

# Smart relays Zelio Logic

Catalog

September 2018

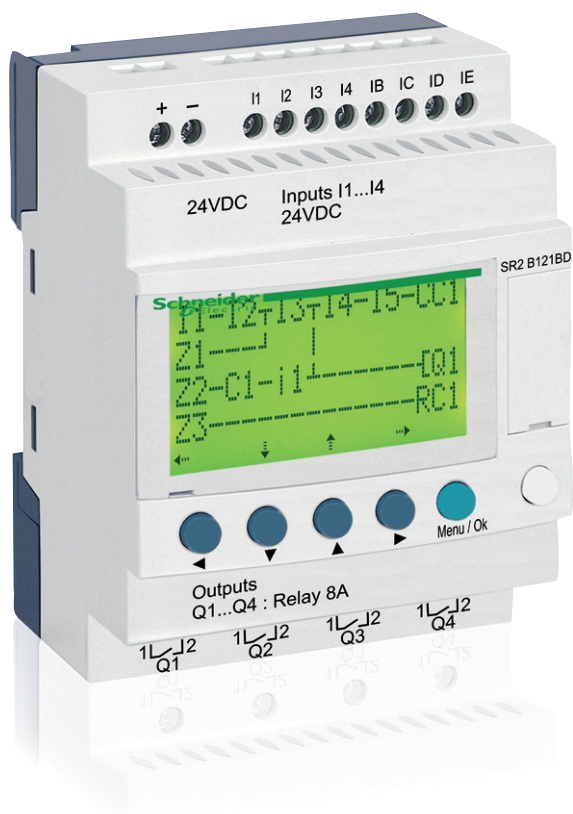

# Quick access to Product information

## Select your Catalog, your Training

### Digi-Cat

The complete digital catalog for industrial automation



Makes your choice easy every day, everywhere!



With just 3 clicks, you can reach the 7,000 pages of the Industrial Automation & Control catalog, in both English and French.

- Digi-Cat is available on a USB key (for PC). To get your Digi-Cat, please contact your local center
- Download Digi-Cat from this address:

<http://digi-cat.schneider-electric.com/download.html>



### Find your training

- Find the right training for your needs
- Locate the training center with the selector tool, using this address:

<http://b2b/en/services/training/technical-training.jsp>

then click on

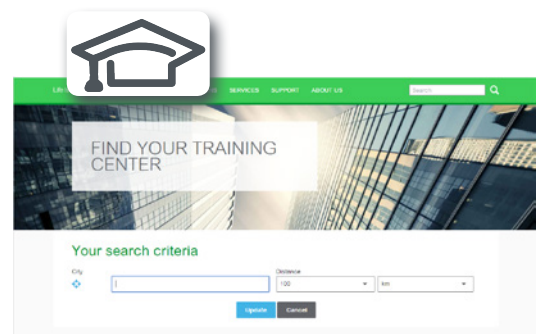
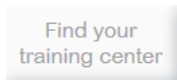

Life Is On



# Contents

## Zelio Logic - Smart relays

**General** ..... page 2

### Selection guides:

- *Compact smart relays* ..... page 4
- *Modular smart relays and extensions* ..... page 6

### ■ Compact and modular smart relays

- Presentation ..... page 8
- Functions
  - Definitions ..... page 12
  - Preset functions ..... page 13
  - SFC (GRAFCET) function ..... page 13
  - Logic function ..... page 13
  - Macro function ..... page 14
  - PID function ..... page 14
- Description
  - Compact smart relays ..... page 15
  - Modular smart relays ..... page 15
  - Digital I/O extension module ..... page 15
- References
  - Compact smart relays with display ..... page 16
  - Modular smart relays ..... page 18
  - Digital I/O extension module ..... page 19
  - Software ..... page 20
  - Dedicated HMI ..... page 20
  - Connection accessories ..... page 20
  - Memory cartridge ..... page 20
  - Mounting accessories ..... page 21

### ■ Communication

- Presentation ..... page 22
- Programming protocol description ..... page 23
- Communication protocol: Modbus serial link
  - Presentation ..... page 24
  - Connection examples ..... page 25
  - Functions ..... page 26
  - References ..... page 29
- Communication protocol: Ethernet Modbus/TCP
  - Presentation, description ..... page 27
  - Functions ..... page 28
  - References ..... page 29

### ■ Analogue I/O extension module

- Presentation, description ..... page 30
- References ..... page 31

### ■ Modem communication interface

- Presentation, description ..... pages 32 and 33
- Functions, Setting-up ..... pages 34 and 35
- References ..... page 35

## Analogue interfaces

**Selection guide** ..... page 36

- Presentation ..... page 38
- References ..... page 40

## Product reference index

■ **index** ..... page 42

# Zelio Logic - Smart relays

Smart relays for simple automation solutions

Step into an intuitive world!

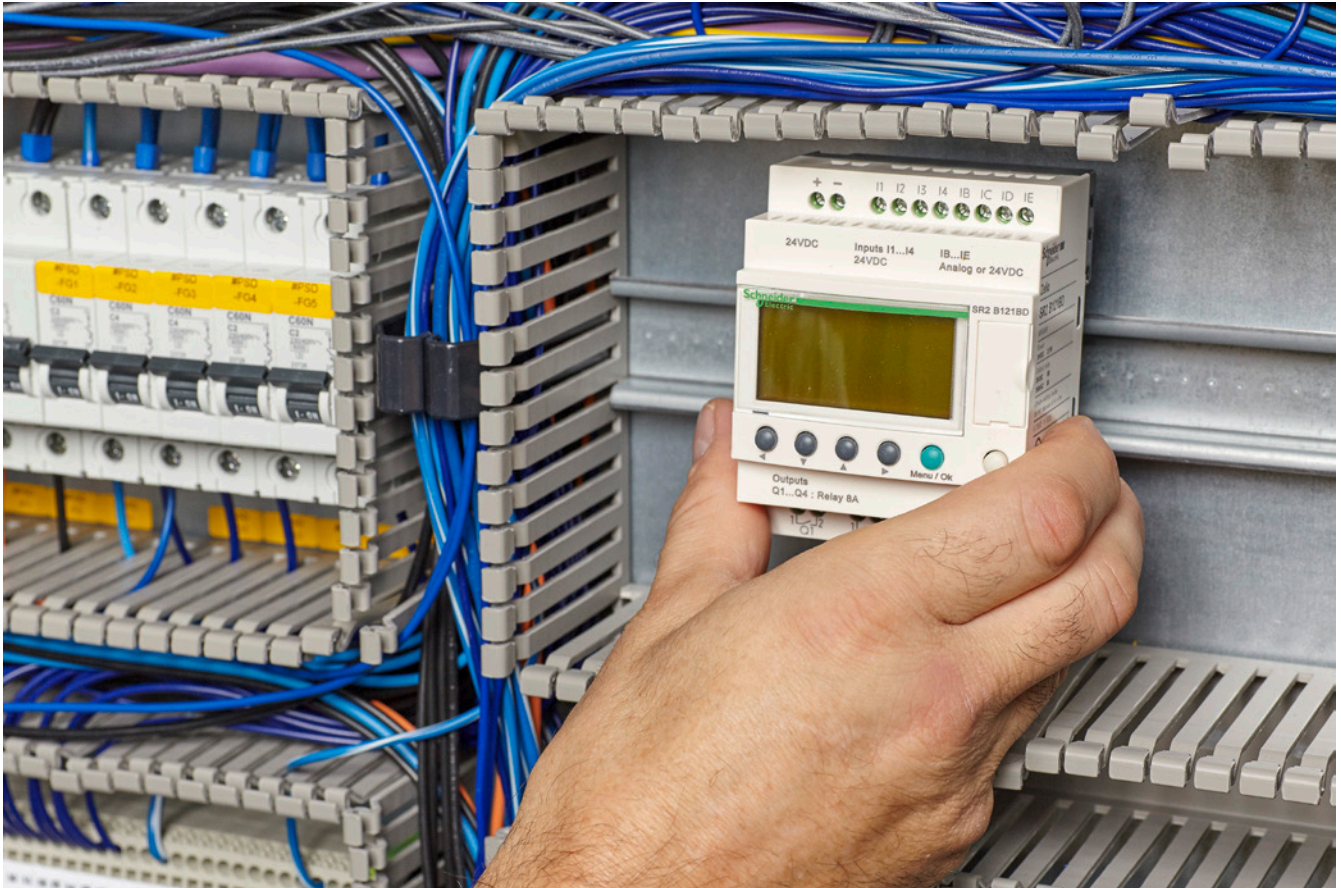

Designed for the management of simple automation systems, Zelio Logic smart relays, with their unique combination of value for money and ease of use, provide a real alternative to solutions based on cabled logic or specific cards.

Simple to select, install, and program, Zelio Logic is suitable for all your applications.

Flexible, it offers you the choice of two ranges:

- > Compact versions with fixed configurations
- > Modular versions that allow the use of extension modules

with two programming languages (FBD or ladder).

## Benefits

- Higher performance

  - > 2x more programming memory and more function blocks by simply updating the firmware
- Greater functionality

  - > PID function for HVAC applications and 2G/3G modems
- Greater efficiency, less engineering time

  - > Free software and firmware downloadable from the Schneider Electric website
  - > Get to grips with software in less than an hour, simplified tool-free programming in ladder or function block diagram (FBD) and SFC languages for small applications
  - > Access to the ladder program and modification of settings on integrated display
- More flexibility - Easy design, maintenance, and commissioning

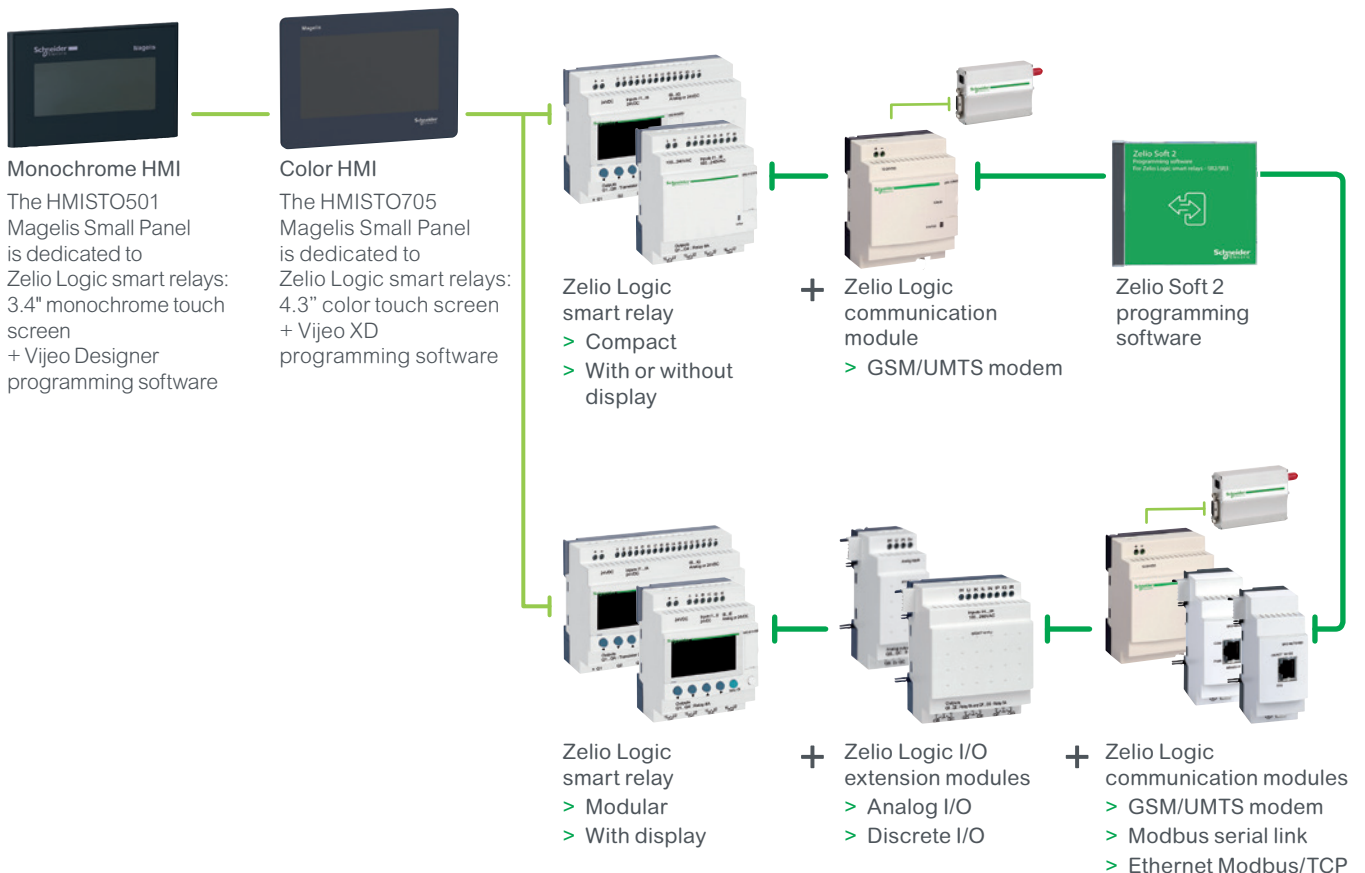

  - > Compact and modular smart relay range with expandable units
  - > Programmable logic: a smart alternative to cabled logic or specific cards

## System components



# Zelio Logic - Smart relays

## Compact smart relays

Product type		Compact smart relays												
														
Supply voltage		24 V ~			48 V ~			100...240 V ~			12 V DC		24 V DC	
Number of I/O		12	20	20	10	12	20	12	20	10	12	20		
Number of discrete inputs (including analog inputs)		8 (0)	12 (0)	12 (0)	6 (0)	8 (0)	12 (0)	8 (4)	12 (6)	6 (0)	8 (4)	12 (2), 12 (6)		
Number of "relay"/"transistor" outputs		4/0	8/0	8/0	4/0	4/0	8/0	4/0	8/0	4/0	4/0, 0/4	8/0, 0/8		
With display, with clock Programming language		SR2B●●1B FBD (1) or LADDER			-			SR2B●●●1FU FBD (1) or LADDER		SR2B●●1JD FBD (1) or LADDER		SR2B●●●BD FBD (1) or LADDER		
With display, without clock Programming language		-			SR2A201E LADDER only			SR2A●●●1FU LADDER only		-		SR2A●●●BD LADDER only		
Without display, with clock Programming language		SR2E●●1B FBD (1) or LADDER			-			SR2E●●●1FU FBD (1) or LADDER		-		SR2E●●●BD FBD (1) or LADDER		
Without display, without clock Programming language		-			-			SR2D●●●1FU LADDER only		-		SR2D●●●BD LADDER only		
Programming software (see page 20)		"Zelio Soft 2" SR2SFT01												
Connection accessories (see page 20)	Serial link cable	SR2CBL01												
	USB connecting cable	SR2USB01												
	Magelis terminal connecting cable	SR2CBL08 for XBTR, XBTR, and XBTRT Magelis terminals SR2CBL09 for HMISTO501 and HMISTO705 Magelis terminals												
	Bluetooth interface	SR2BTC01												
Memory cartridge (see page 20)		SR2MEM02 (⚠ incompatible with SR2COM01)												
"Discovery" packs (see page 18)		-												
Modem communication interface (see page 35)		SR2COM01												
GSM/UMTS modem (see page 35)		SR2MOD02												
Alarm management software (see page 35)		"Zelio Logic Alarm" SR2SFT02												
Converters (thermocouple types J and K, Pt100 probes and voltage/current)		-												
Power supplies for DC control circuit		-												
References		SR2●●●1B			SR2A201E			SR2●●●1FU		SR2B●●1JD		SR2●●●BD		
Pages		16 and 17			16			16 and 17		16		16 and 17		

(1) FBD: Function Block Diagram

Please consult our catalog (n° DIA3ED2170401EN) and on our website

**Product type**

**Modular smart relays**



<b>Supply voltage</b>	24 V ~		100...240 V ~	
<b>Number of I/O</b>	10	26	10	26
<b>Number of discrete inputs (including analog inputs)</b>	6 (0)	16 (0)	6 (0)	16 (0)
<b>Number of "relay"/"transistor" outputs</b>	4/0	10/0	4/0	10/0
<b>With display, with clock</b>	Yes			
<b>Programming language</b>	FBD (1) or LADDER			
<b>Programming software (see page 20)</b>	"Zelio Soft 2" SR2SFT01			
<b>Connection accessories (see page 20)</b>	Serial link cable SR2CBL01 USB connecting cable SR2USB01 Magelis terminal connecting cable SR2CBL08 for XBTN, XBTR, and XBTRT Magelis terminals SR2CBL09 for HMISTO501 and HMISTO705 Magelis terminals Bluetooth interface SR2BTC01			
<b>Memory cartridge (see page 20)</b>	SR2MEM02 (⚠ incompatible with SR2COM01)			
<b>"Discovery" packs (see page 18)</b>	-		SR3PACK●BD	
<b>Modem communication interface (see page 35)</b>	SR2COM01			
<b>GSM/UMTS modem (see page 35)</b>	SR2MOD02			
<b>Alarm management software (see page 35)</b>	"Zelio Logic Alarm" SR2SFT02			
<b>Converters (thermocouple types J and K, Pt100 probes, and voltage/current)</b>	-			
<b>Power supplies for DC control circuit</b>	-			
<b>References</b>	SR3B●●1B		SR3B●●1FU	
<b>Pages</b>	18		18	



<b>Supply voltage</b>	12 V DC		24 V DC	
<b>Number of I/O</b>	26	10	26	
<b>Number of discrete inputs (including analog inputs)</b>	16 (6)	6 (4)	16 (6)	
<b>Number of "relay"/"transistor" outputs</b>	10/0	4/0, 0/4	10/0, 0/10	
<b>With display, with clock</b>	Yes			
<b>Programming language</b>	FBD (1) or LADDER			
<b>Programming software (see page 20)</b>	"Zelio Soft 2" SR2SFT01			
<b>Connection accessories (see page 20)</b>	Serial link cable SR2CBL01 USB connecting cable SR2USB01 Magelis terminal connecting cable SR2CBL08 for XBTN, XBTR, and XBTRT Magelis terminals SR2CBL09 for HMISTO501 and HMISTO705 Magelis terminals Bluetooth interface SR2BTC01			
<b>Memory cartridge (see page 20)</b>	SR2MEM02 (⚠ incompatible with SR2COM01)			
<b>"Discovery" packs (see page 18)</b>	-		SR3PACK●BD	
<b>Modem communication interface (see page 35)</b>	SR2COM01			
<b>GSM/UMTS modem (see page 35)</b>	SR2MOD02			
<b>Alarm management software (see page 35)</b>	"Zelio Logic Alarm" SR2SFT02			
<b>Converters (thermocouple types J and K, Pt100 probes, and voltage/current)</b>	-			
<b>Power supplies for DC control circuit</b>	-			
<b>References</b>	SR3B261JD		SR3B●●●BD	
<b>Pages</b>	18		18	

Please consult our catalog (n° DIA3ED2170401EN) and on our website

**Associated extensions**

**Discrete I/O extensions**



<b>Number of I/O</b>	6	10	14	6	10	14
<b>Type and number of discrete inputs (or analog inputs)</b>	4 (0)	6 (0)	8 (0)	4 (0)	6 (0)	8 (0)
<b>Type and number of relay outputs (or analog outputs)</b>	2 (0)	4 (0)	6 (0)	2 (0)	4 (0)	6 (0)
<b>References</b>	SR3XT●●●B			SR3XT●●●FU		
<b>Pages</b>	19			19		

(1) FBD: Function Block Diagram

**Network communication extensions**



<b>Number of I/O</b>	6	10	14					4	6	10	14
<b>Type and number of discrete inputs (or analog inputs)</b>	4 (0)	6 (0)	8 (0)	■ Number of words: <input type="checkbox"/> 4 (inputs) <input type="checkbox"/> 4 (outputs) <input type="checkbox"/> 4 (clock) <input type="checkbox"/> 1 (status)		■ Number of words: <input type="checkbox"/> 4 (inputs) <input type="checkbox"/> 4 (outputs) <input type="checkbox"/> 4 (clock) <input type="checkbox"/> 1 (status)		0 (2)	4 (0)	6 (0)	8 (0)
<b>Type and number of relay outputs (or analog outputs)</b>	2 (0)	4 (0)	6 (0)					0 (2)	2 (0)	4 (0)	6 (0)
<b>References</b>	SR3XT●●●JD			SR3MBU01BD	SR3NET01BD	SR3XT43BD		SR3XT●●●BD			
<b>Pages</b>	19			29		31		19			



Zelio Logic compact smart relay

### Combination of modular smart relays and extensions



- 1 Modular Zelio Logic smart relay (10 or 26 I/O)
- 2 Discrete (6, 10, or 14 I/O) or analog (4 I/O) I/O extension

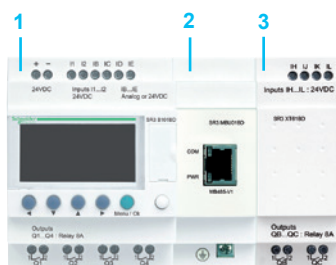

- 1 Modular Zelio Logic smart relay (10 or 26 I/O)
- 2 Modbus serial link or Ethernet Modbus/TCP network communication extensions
- 3 Discrete (6, 10, or 14 I/O) or analog (4 I/O) I/O extension

⚠ Observe the order of assembly above when using a Modbus slave or Ethernet server network communication extension and a discrete or analog I/O extension. An I/O extension cannot be inserted before a network communication extension.

### Presentation

Zelio Logic smart relays are designed for use in small automated systems. They are used in both the industrial and commercial sectors.

- **For industry:**
  - automation of small finishing, production, assembly, or packaging machines
  - small automated systems operating at 48 V ~ (hoisting application, etc.)
  - decentralized automation of ancillary equipment for large and medium-sized machines (in the textile, plastics, materials processing sectors, etc.)
  - automation systems for agricultural machinery (irrigation, pumping, greenhouses, etc.)
- **For the commercial/building sectors:**
  - automation of barriers, roller shutters, access control
  - automation of lighting systems
  - automation of compressors and air conditioning systems
  - etc.

Their compact size and ease of setup make them a competitive alternative to solutions based on cabled logic or specific cards.

### Programming

Simple programming, backed up by the universal nature of the languages, meets the requirements of automation specialists and the needs of electricians.

Programming can be performed:

- locally, using the buttons on the Zelio Logic smart relay (ladder language)
- on a PC using “Zelio Soft 2” software

When using a PC, programming can be performed either in ladder language or in function block diagram (FBD) language (see page 10).

The LCD display unit backlight (1) is activated by pressing one of the 6 programming buttons on the Zelio Logic smart relay or by programming with “Zelio Soft 2” software (e.g. flashing when diagnosing a malfunction).

The clock has a lithium battery, which gives it an independent operating time of 10 years.

Data backup (preset values and current values) is provided by an EEPROM Flash memory (with the same lifetime as the smart relay).

### Compact smart relays

Compact smart relays meet requirements for simple automation systems.

The number of I/O can be:

- 12 or 20 I/O, supplied with 24 V ~ or 12 V = power
- 20 I/O, supplied with 48 V ~ power
- 10, 12, or 20 I/O, supplied with 100...240 V ~ or 24 V = power

### Modular smart relays and extensions

The number of I/O for modular smart relays can be:

- 26 I/O, supplied with 12 V = power
- 10 or 26 I/O, supplied with 24 V ~, 100...240 V ~, or 24 V = power

To improve performance and flexibility, Zelio Logic modular smart relays can take extensions to obtain a maximum of 40 I/O.

- Modbus serial link or Ethernet Modbus/TCP network communication extensions, supplied with 24 V = power via the Zelio Logic smart relay at the same voltage
- analog I/O extension with 4 I/O, supplied with 24 V = power via the Zelio Logic smart relay at the same voltage
- discrete I/O extensions with 6, 10, or 14 I/O, supplied with power via the Zelio Logic smart relay at the same voltage

(1) LCD: Liquid crystal display



Connecting cable



Bluetooth interface



Memory cartridge



Modbus serial link communication extension



Ethernet Modbus/TCP communication extension



Modem communication interface



GSM/UMTS modem interface



HMISTO705 Small Panel



Zelio Logic compact smart relay + SR2CBL09 cable

### Communication

#### Cabled and wireless programming tools

- These programming tools allow the Zelio Logic smart relay to be connected to a PC running “Zelio Soft 2” software:
  - Cable connection:
    - SR2USB01 cable to USB port
    - or
    - SR2CBL01 cable to 9-way serial port
  - Wireless link:
    - SR2BTC01 Bluetooth interface

#### ■ Memory cartridge

The Zelio Logic smart relay can take a backup memory cartridge that allows the application program to be copied to another Zelio Logic smart relay (it is only possible to load and update the firmware with the SR2MEM02 memory cartridge).

The memory cartridge also enables a backup copy of the program to be saved prior to replacing the product.

When used with a smart relay without display or buttons, the copy of the program contained in the cartridge is automatically transferred to the Zelio Logic smart relay on power-up.

#### Modbus serial link and Ethernet Modbus/TCP communication extensions

The Modbus serial link and Ethernet Modbus/TCP network communication extension modules allow connection to automation system equipment such as display units or PLCs (see page 22).

#### Modem communication interface

The “modem communication interface” offer in the Zelio Logic range includes:

- an SR2COM01 modem communication interface connected between a Zelio Logic smart relay and a modem
- an SR2MOD02 GSM/UMTS (1) modem
- SR2SFT02 “Zelio Logic Alarm” software

This offer is designed for monitoring or remote control of machines or installations that operate without personnel.

The modem communication interface, supplied with 12...24 V  $\overline{\text{DC}}$  power, enables messages, phone numbers, and calling conditions to be stored (see page 32).

#### HMI terminals

HMISTO Small Panels offer added value to the equipment by enabling the creation of eye-catching dialog screens.

They are available in monochrome (HMISTO501) or color (HMISTO705) versions. They connect directly to the front panel of the smart relays in the memory cartridge slot via the special cable (SR2CBL09).

The terminals are configured using Vijeo Designer (HMISTO501) or Vijeo XD (HMISTO705) software. Exchanges with the smart relay are simplified using the SLIn and SLout data exchange blocks in “Zelio Soft 2” (FBD language only). 24 words can be exchanged in each direction.

(1) Global System Mobile (2G)/Universal Mobile Telecommunications System (3G)

# Zelio Logic - Smart relays

## Compact and modular smart relays

### “Zelio Soft 2” programming software

#### “Zelio Soft 2” for PC - version 5.1 (1)

“Zelio Soft 2” software enables:

- programming in ladder language or function block diagram (FBD) language (see page 12)
- simulation, monitoring, and supervision
- uploading and downloading of programs
- print-out of customized files
- automatic program compilation
- online help

#### Consistency checks and application languages

“Zelio Soft 2” monitors applications by means of its consistency check function. An indicator turns red at the slightest input error (ladder language). The problem can be located simply by clicking the mouse.

“Zelio Soft 2” software allows users to switch between the 6 languages (English, French, German, Italian, Portuguese, and Spanish) at any time and edit the application file in the selected language.

#### Inputting messages for display on Zelio Logic

“Zelio Soft 2” software allows text function blocks to be configured, which can then be displayed on Zelio Logic smart relays that have a display.

#### Program testing

2 test modes are provided:

- The **simulation** mode in “Zelio Soft 2” is used to test a program without a Zelio Logic smart relay, i.e. to:
  - enable discrete inputs
  - display output status
  - vary the voltage of the analog inputs
  - enable the programming buttons
- simulate the application program in real time or in accelerated time
- display the different active program elements dynamically in red
- The **monitoring** is used to test the program executed by the smart relay, i.e. to:
  - display the program “online”
  - force inputs, outputs, auxiliary relays, and current function block values
  - adjust the date and time
  - switch from STOP mode to RUN mode and vice versa

In simulation or monitoring mode, the supervision window allows users to view the status of the smart relay I/O within the application environment (diagram or image).

(1) These functions exist for versions  $\geq$  V 5.1.

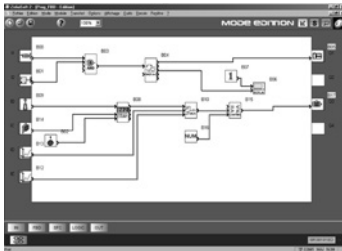

Programming in FBD language

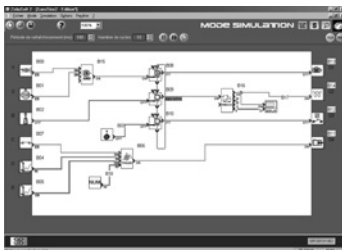

Simulation mode

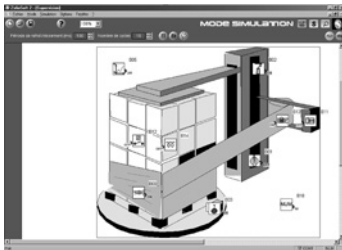

Monitoring window

## User interfaces

“Zelio Soft 2” software (versions ≥ 4.1) improves the ease of use of user interfaces for the following functions:

### “Split wiring sheet” function (ladder and FBD language)

The wiring sheet can be split into 2 to allow two separate parts of the wiring sheet to be displayed on the same screen.

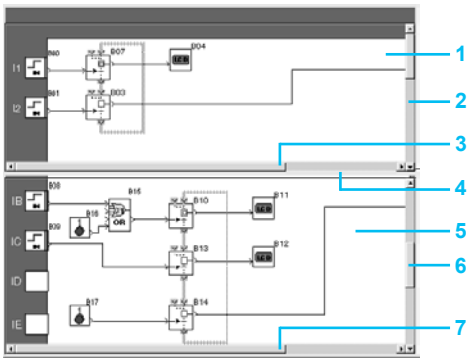

Structure of a split wiring sheet

This can be used to:

- Display the required function blocks in the top and bottom parts of the screen
- Move the split bar as required
- Connect the function blocks between the 2 parts of the wiring sheet

The split wiring sheet is structured as follows:

- 1 View of top part
- 2 Top window vertical scroll bar
- 3 Top window horizontal scroll bar
- 4 Split bar
- 5 View of bottom part
- 6 Bottom window vertical scroll bar
- 7 Bottom window horizontal scroll bar

### “Replace function block” function (FBD language)

This function allows a block to be replaced without losing the input and output connections.

E.g. replacing an “OR” block with a “NOR” block

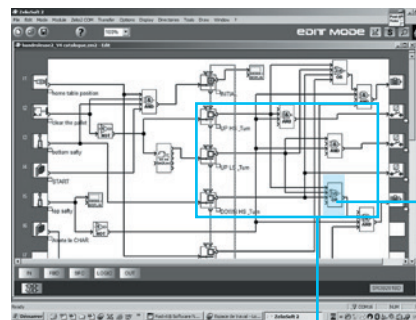

- 1 “OR” block to be replaced

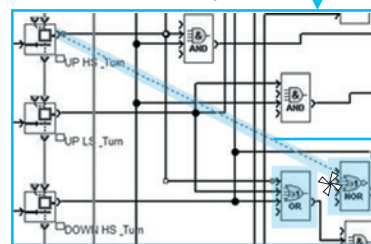

- 2 Move the links to the new “NOR” block

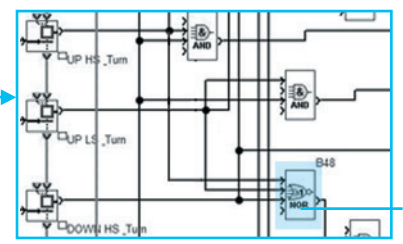

- 3 Delete the “OR” block and position the “NOR” block in its place



2

1

“Acceleration and simulation terminals” window

### “Time Prog simulation” function (ladder and FBD languages)

Ladder or FBD program simulation mode allows the program to be debugged by simulating it on the software workshop host computer.

A function allows the time on the simulator clock to be modified by setting it to 3 s before the start of the next event .

The “Next event” button 1 is used to modify the simulator clock 2.

## Ladder language

### Definitions



Text function block



Timer



Up/down counter



Fast counter



Analog comparator



Clock



Auxiliary relay



Counter comparator



LCD backlight



Daylight saving time change



Output coil



Message

Ladder language enables a ladder program to be written with elementary functions, elementary function blocks, and derived function blocks, as well as with contacts, coils, and variables.

The contacts and coils can be annotated. Text can be placed freely within the graphic.

#### ■ Ladder diagram input modes

“Zelio input” mode allows users who have programmed the Zelio Logic smart relay directly on the device to achieve the same ease of use, even when using the software for the first time.

“Ladder input” mode, which is more intuitive, is very user-friendly and incorporates many additional features.

Two types of symbol can be used in ladder programming language:

- ladder symbols
- electrical symbols

“Ladder input” mode also allows the creation of mnemonics and comments associated with each program line.

Instant switching from one input mode to the other is possible at any time, simply by clicking the mouse.

Up to 240 (1) ladder diagram lines can be programmed, with 5 contacts and 1 coil per program line.

#### ■ Functions

- 16 text function blocks
- 28 (1) timers, each of which can be configured from among 11 different types (from 1/10 second to 9,999 hours)
- 28 (1) up/down counters from 0 to 32,767
- 1 fast counter (1 kHz)
- 16 analog comparators
- 8 clocks, each with 4 channels
- 56 (1) auxiliary relays
- 8 counter comparators
- LCD screen with programmable backlight
- automatic daylight saving time changeover
- variety of functions: coil, latching (Set/Reset), impulse relay, contactor
- 28 message blocks (with modem communication interface, see page 32)

### Functions

Function	Electrical scheme	Ladder language	Comment
Contact			I corresponds to the real state of the contact wired to the smart relay input. i corresponds to the inverse state of the contact wired to the smart relay input.
Standard coil			The coil is energized when the contacts to which it is connected are closed.
Latch coil (Set)			The coil is energized (set) when the contacts to which it is connected are closed. It remains energized even if the contacts are no longer closed.
Unlatch coil (Reset)			The coil is de-energized (reset) when the contacts to which it is connected are closed. It remains de-energized even if the contacts are no longer closed.

(1) Possible using version V5.0 and above of “Zelio Soft 2” provided that the SR2COM01 communication module is not used. If this module is used, 16 timers, 16 counters, and 32 auxiliary relays are available and the program is limited to 120 ladder diagram lines.

## Function block language (FBD/Grafcet SFC/logic functions) (1)

















































### Definition

FBD language allows graphical programming based on the use of predefined function blocks, and provides the use of:

- 35 preprogrammed functions for counting, time delay, timing, switching threshold definition (e.g. temperature regulation), pulse generation, time programming, multiplexing, and display
- 7 SFC functions
- 6 logic functions

### Pre-programmed functions

Zelio Logic smart relays provide a high processing capacity, up to 500 (2) function blocks, including 35 pre-programmed functions:

 <b>TIMER AC</b> TIMER A+C	 <b>TIMER BH</b> TIMER B+H	 <b>TIMER Li</b> TIMER Li	 <b>TIMER BW</b> TIMER B+W	 <b>TIMER AC</b> TIMER A+C	
Timer. Function A/C (ON-delay and OFF-delay)	Timer. Function BH (adjustable pulsed signal)	Pulse generator (ON-delay, OFF-delay)	Timer. Function BW (pulse on rising/falling edge)	Timer. Function A/C with external preset adjustment (ON-delay and OFF-delay)	
 <b>TIMER BH</b> TIMER B+H	 <b>TIMER Li</b> TIMER Li	 <b>BISTABLE</b> BISTABLE	 <b>SET-RESET</b> SET Q RESET	 <b>BOOLEAN</b> BOOLEAN	
Timer. Function BH with external preset adjustment (adjustable pulsed signal)	Pulse generator with external preset adjustment (ON-delay, OFF-delay)	Impulse relay function	Bistable latching - Priority assigned either to SET or RESET function	Allows logic equations to be created between connected inputs	
 <b>CAM</b> CAM	 <b>PRESET COUNT</b> PRESET COUNT	 <b>UP DOWN COUNT</b> UP DOWN COUNT	 <b>PRESET H-METER</b> PRESET H-METER	 <b>TIME PROG</b> TIME PROG	
Cam programmer	Up/down counter	Up/down counter with external preset	Hour counter (hour, minute preset)	Time programmer, weekly and annual	
 <b>GAIN</b> GAIN	 <b>TRIGGER</b> TRIGGER	 <b>MUX</b> MUX	 <b>COMP IN ZONE</b> MAX VAL MIN	 <b>ADD/SUB</b> + - =	
Allows conversion of an analog value by change of scale and offset	Defines an activation zone with hysteresis	Multiplexing functions on 2 analog values	Zone comparison (Min. ≤ Value ≤ Max.)	Add and/or subtract function	
 <b>MUL/DIV</b> x / =	 <b>TEXT</b> TEXT	 <b>DISPLAY</b> DISPLAY	 <b>COM</b> COM	 <b>COMPARE</b> COMPARE	
Multiply and/or divide function	Display of digital and analog data, date, time, messages for Human-Machine interface	Display of digital and analog data, date, time, messages for Human-Machine interface	Sending of messages with communication interface (see page 32)	Comparison of 2 analog values using the operands =, >, <, ≤, ≥, ≠	
 <b>STATUS</b> STATUS	 <b>ARCHIVE</b> ARCHIVE	 <b>SPEED COUNT</b> SPEED COUNT	 <b>CAN</b> CAN	 <b>CNA</b> CNA	
Access to smart relay status	Storage of 2 values simultaneously	Fast counting up to 1 kHz	Analog-to-digital converter	Digital-to-analog converter	
 <b>SL In</b> In	 <b>SL Out</b> Out	 <b>SUNTRACK</b> SUN SET RISE	 <b>SUNRISE/SUNSET</b> SUN RISE SET	 <b>PID</b> (n)	
Input of a word via serial link	Output of a word via serial link	Tracks the sun's position	Outputs the sunrise and sunset times	Temperature, level, flow rate, or pressure control functions	
<b>SFC functions (3) (GRAF CET)</b>					
 <b>RESET-INIT</b> RESET-INIT	 <b>INIT STEP</b> INIT STEP	 <b>STEP</b> STEP	 <b>DIV-OR 2</b> DIV-OR 2	 <b>CONV-OR 2</b> CONV-OR 2	
Reset initial step	Initial step	SFC step	Divergence to OR	Convergence to OR	
 <b>DIV-AND 2</b> DIV-AND 2	 <b>CONV-AND 2</b> CONV-AND 2				
Divergence to AND	Convergence to AND				
<b>Logic functions</b>					
 <b>AND</b> AND	 <b>OR</b> OR	 <b>NAND</b> NAND	 <b>NOR</b> NOR	 <b>XOR</b> XOR	 <b>NOT</b> NOT
AND function	OR function	NOT AND function	NOT OR function	Exclusive OR function	NOT function

(n) New feature for 2017

(1) Function block diagram

(2) Possible in version V5.0 or above of "Zelio Soft 2"

(3) Sequential function chart

## Function block language (FBD/Grafset SFC/logic functions) (continued)

### Macro function

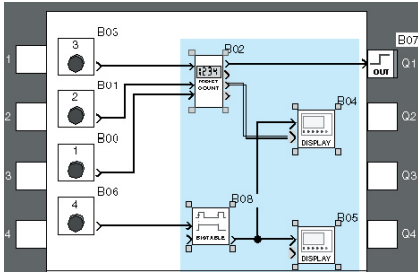

Creating a macro

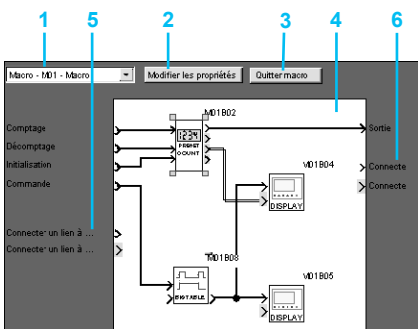

Inside a macro

- 1 Select macro
- 2 Edit properties
- 3 Return to external view of a macro
- 4 Internal function block in the macro
- 5 Non-connected inputs
- 6 Non-connected outputs

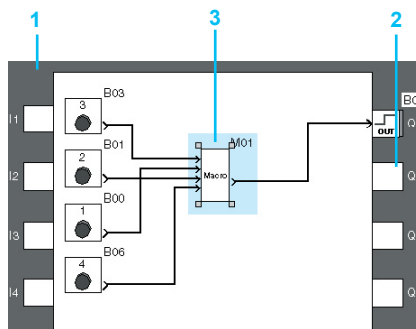

External view of a macro

- 1 Input connections
- 2 Output connection
- 3 Macro function block

A macro is a group of function blocks. It is characterized by its number, name, links, internal function blocks (255 max.), and its I/O connections.

Seen from the outside, a macro behaves like a function block with inputs and/or outputs likely to be connected to links.

Once created, a macro can be manipulated like a function block.

■ Macro characteristics:

- The maximum number of macros is 64.
- A password dedicated to macros can be used to protect their content.
- A macro can be edited/duplicated.
- A macro's comments can be edited.

■ Macro properties:

A "Macro Properties" dialog box is used to enter or modify the properties of a macro. The properties of a macro are as follows:

- Macro name (optional)
- Block symbol, which may be:
  - an identifier
  - an image
- Name of inputs
- Name of outputs

### PID function

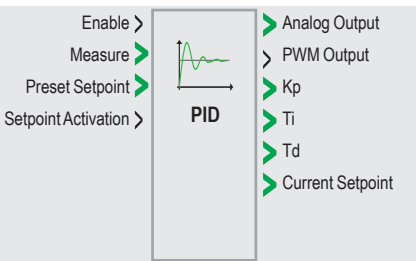

Programming the PID function

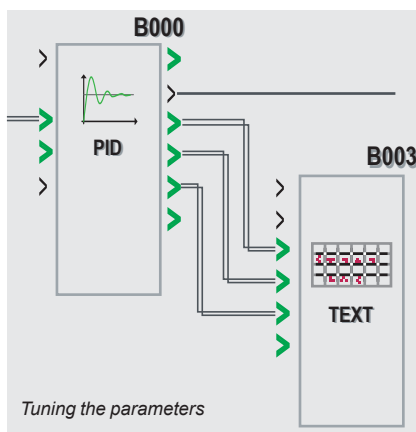

Tuning the parameters

#### Presentation

The PID function block is used to program simple temperature, level, or pressure control functions.

Two types of output enable adaptation to the most common actuators available on the market:

- Analog output, requiring the use of a modular smart relay and an analog I/O extension
- PWM output, enabling the integrated outputs in any smart relay to be used.

Depending on the period set for PWM, and to help extend service life, a smart relay equipped with transistor outputs is recommended.

#### Programming

PID function blocks are available in FBD language. To help with tuning, default parameters are available for several typical applications (flow, level, pressure, temperature). These parameters can be modified.

#### Tuning

The TEXT and DISPLAY function blocks are used to help tune the control parameters (Kp, Ti, Td) without using Zelio Soft 2: the parameters can be modified directly using the buttons on the front of the smart relay and the display.

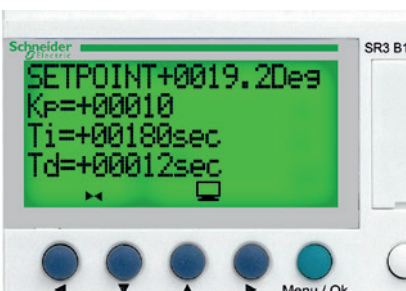

Modifying parameters (Kp, Ti, Td) using the programming and parameter setting buttons

## Compact smart relays

With display - 10, 12, and 20 I/O

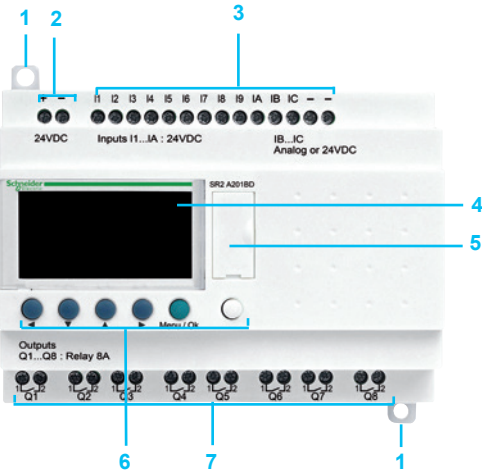

Without display - 10, 12, and 20 I/O

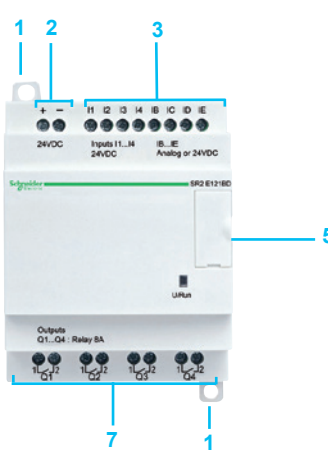

Zelio Logic compact smart relay front panels comprise:

- 1 Two retractable mounting feet
- 2 Two power supply terminals
- 3 Terminals for connecting the inputs
- 4 Backlit LCD display with 4 lines of 18 characters
- 5 Slot for memory cartridge or connection to PC, modem communication interface, HMI terminal (Magelis Small Panel), or Bluetooth interface
- 6 6 buttons for programming and parameter entry
- 7 Terminals for connecting the outputs

## Modular smart relays

With display - 10 and 26 I/O

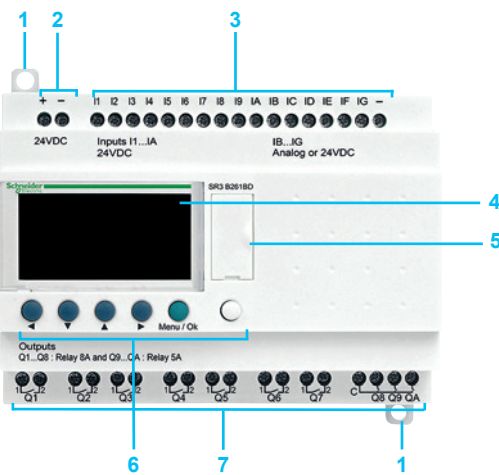

Zelio Logic modular smart relay front panels comprise:

- 1 Two retractable mounting feet
- 2 Two power supply terminals
- 3 Terminals for connecting the inputs
- 4 Backlit LCD display with 4 lines of 18 characters
- 5 Slot for memory cartridge or connection to PC, modem communication interface, HMI terminal (Magelis Small Panel), or Bluetooth interface
- 6 6 buttons for programming and parameter entry
- 7 Terminals for connecting the outputs

## Discrete I/O extensions

6 discrete I/O



10 and 14 discrete I/O

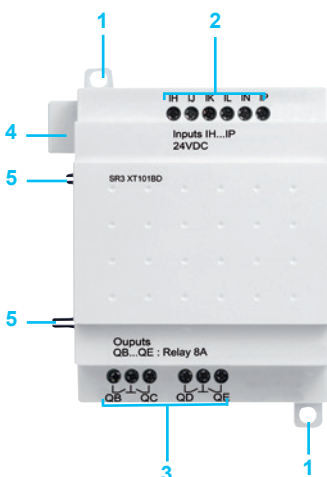

Discrete I/O extension front panels comprise:

- 1 Two retractable mounting feet
- 2 Terminals for connecting the inputs
- 3 Terminals for connecting the outputs
- 4 Connector for connection to the Zelio Logic smart relay (powered via the Zelio Logic smart relay)
- 5 Locating pegs

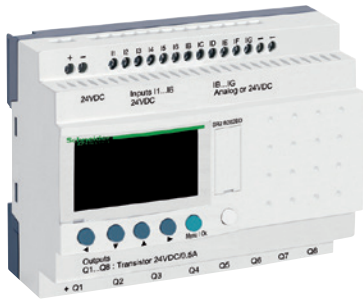

SR2A201BD



SR2SFT01



SR2PACK...



Modem communication interface

### Compact smart relays with display

Number of I/O	Discrete inputs	Including 0-10 V $\overline{\text{---}}$ analog inputs	Relay outputs	Transistor outputs	Clock	Reference	Weight kg lb
<b>24 V <math>\sim</math> power supply</b>							
12	8	0	4	0	Yes	SR2B121B	0.250 0.551
20	12	0	8	0	Yes	SR2B201B	0.380 0.838
<b>48 V <math>\sim</math> power supply</b>							
20	12	0	8	0	No	SR2A201E (1)	0.380 0.838
<b>100...240 V <math>\sim</math> power supply</b>							
10	6	0	4	0	No	SR2A101FU (1)	0.250 0.551
12	8	0	4	0	Yes	SR2B121FU	0.250 0.551
20	12	0	8	0	No	SR2A201FU (1)	0.380 0.838
					Yes	SR2B201FU	0.380 0.838
<b>12 V <math>\overline{\text{---}}</math> power supply</b>							
12	8	4	4	0	Yes	SR2B121JD	0.250 0.551
20	12	6	8	0	Yes	SR2B201JD	0.380 0.838
<b>24 V <math>\overline{\text{---}}</math> power supply</b>							
10	6	0	4	0	No	SR2A101BD (1)	0.250 0.551
					Yes	SR2B121BD	0.250 0.551
20	12	2	8	0	Yes	SR2B122BD	0.220 0.485
					No	SR2A201BD (1)	0.380 0.838
					Yes	SR2B201BD	0.380 0.838
		6	8	0	Yes	SR2B202BD	0.280 0.617

### "Zelio Soft 2" software

See page 20

### Connection accessories

See page 20

### Compact "discovery" packs

Pack contents:

- Compact smart relay with display SR2B.....
- + "Zelio Soft 2" programming software on CD-ROM SR2SFT01
- + PC connecting cable SR2USB01

Number of I/O	Pack contents (references)	Reference	Weight kg lb
<b>100...240 V <math>\sim</math> power supply</b>			
12	SR2B121FU	SR2PACKFU	0.700 1.543
	+ SR2SFT01 + SR2USB01		
20	SR2B201FU	SR2PACK2FU	0.850 1.874
	+ SR2SFT01 + SR2USB01		
<b>24 V <math>\overline{\text{---}}</math> power supply</b>			
12	SR2B121BD	SR2PACKBD	0.700 1.543
	+ SR2SFT01 + SR2USB01		
20	SR2B201BD	SR2PACK2BD	0.700 1.543
	+ SR2SFT01 + SR2USB01		

### Modem communication interface

#### 12...24 V $\overline{\text{---}}$ power supply

Description	Reference
Modem communication interface	See page 32

(1) Programming in ladder language only



SR2E121BD



SR2SFT01



SR2USB01



Modem communication interface

### Compact smart relays without display

Number of I/O	Discrete inputs	Including 0-10 V $\overline{\text{---}}$ analog inputs	Relay outputs	Transistor outputs	Clock	Reference	Weight kg lb
<b>24 V <math>\sim</math> power supply</b>							
12	8	0	4	0	Yes	SR2E121B	0.220 0.485
20	12	0	8	0	Yes	SR2E201B	0.350 0.772
<b>100...240 V <math>\sim</math> power supply</b>							
10	6	0	4	0	No	SR2D101FU (1)	0.220 0.485
12	8	0	4	0	Yes	SR2E121FU	0.220 0.485
20	12	0	8	0	No	SR2D201FU (1)	0.350 0.772
					Yes	SR2E201FU	0.350 0.772
<b>24 V <math>\overline{\text{---}}</math> power supply</b>							
10	6	0	4	0	No	SR2D101BD (1)	0.220 0.485
12	8	4	4	0	Yes	SR2E121BD	0.220 0.485
20	12	2	8	0	No	SR2D201BD (1)	0.350 0.772
		6	8	0	Yes	SR2E201BD	0.350 0.772

### “Zelio Soft 2” software

See page 20

### Accessories

See page 20

### Modem communication interface

12...24 V $\overline{\text{---}}$ power supply	
Description	Reference
Modem communication interface	See page 32

(1) Programming in ladder language only

# Zelio Logic - Smart relays

## Modular smart relays



SR3B261B



SR2SFT01



SR3PACK●●●

### Modular smart relays with display

Number of I/O	Discrete inputs	Including 0-10 V $\overline{\text{---}}$ analog inputs	Relay outputs	Transistor outputs	Clock	Reference	Weight kg lb
<b>24 V <math>\sim</math> power supply</b>							
10	6	0	4	0	Yes	SR3B101B	0.250 0.551
26	16	0	10 (1)	0	Yes	SR3B261B	0.400 0.882
<b>100...240 V <math>\sim</math> power supply</b>							
10	6	0	4	0	Yes	SR3B101FU	0.250 0.551
26	16	0	10 (1)	0	Yes	SR3B261FU	0.400 0.882
<b>12 V <math>\overline{\text{---}}</math> power supply</b>							
26	16	6	10 (1)	0	Yes	SR3B261JD	0.400 0.882
<b>24 V <math>\overline{\text{---}}</math> power supply</b>							
10	6	4	4	0	Yes	SR3B101BD	0.250 0.551
			0	4	Yes	SR3B102BD	0.220 0.485
26	16	6	10 (1)	0	Yes	SR3B261BD	0.400 0.882
			0	10	Yes	SR3B262BD	0.300 0.661

### "Zelio Soft 2" software

See page 20.

### Connection accessories

See page 20.

### Modular "discovery" packs

Pack contents:  
 Modular smart relay with display SR3B●●●●  
 + "Zelio Soft 2" programming software on CD-ROM SR2SFT01  
 + PC connecting cable SR2USB01

Number of I/O	Pack contents (references)	Reference	Weight kg lb
<b>100...240 V <math>\sim</math> power supply</b>			
10	SR3B101FU	SR3PACKFU	0.700
	+ SR2SFT01 + SR2USB01		1.543
26	SR3B261FU	SR3PACK2FU	0.850
	+ SR2SFT01 + SR2USB01		1.874
<b>24 V <math>\overline{\text{---}}</math> power supply</b>			
10	SR3B101BD	SR3PACKBD	0.700
	+ SR2SFT01 + SR2USB01		1.543
26	SR3B261BD	SR3PACK2BD	0.850
	+ SR2SFT01 + SR2USB01		1.874

(1) Including 8 outputs at maximum current of 8 A and 2 outputs at maximum current of 5 A.

**Note:** The Zelio Logic smart relay and its associated extensions have an identical voltage to be able to operate together.

# Zelio Logic - Smart relays

## Modular smart relays



Modbus serial link communication extension



Ethernet Modbus/TCP communication extension



SR3XT141JD



Modem communication interface

### Communication extension (1)

24 V  $\overline{\text{---}}$  power supply (via SR3B...BD smart relays)

For use with	Communication ports	Reference
SR3B...1BD and SR3B...2BD Zelio Logic modular smart relays	Modbus RS485 serial link (RJ45)	See page 22
	Ethernet Modbus/TCP (RJ45)	See page 22

### Analog I/O extension (2)

24 V  $\overline{\text{---}}$  power supply (via Zelio Logic SR3B...BD smart relay)

Number of I/O	Inputs	Including $\overline{\text{---}}$ 0-10 V	Including $\overline{\text{---}}$ 0-20 mA	Including Pt100	0-10 V $\overline{\text{---}}$ output	Reference
4	2	2 max.	2 max.	1 max.	2	See page 30

### Discrete I/O extensions

Number of I/O	Discrete inputs	Relay outputs	Reference	Weight kg/lb
---------------	-----------------	---------------	-----------	--------------

24 V  $\sim$  power supply (via Zelio Logic SR3B...B smart relays)

6	4	2	SR3XT61B	0.125 0.276
10	6	4	SR3XT101B	0.200 0.441
14	8	6 (3)	SR3XT141B	0.220 0.485

100-240 V  $\sim$  power supply (via Zelio Logic SR3B...FU smart relays)

6	4	2	SR3XT61FU	0.125 0.276
10	6	4	SR3XT101FU	0.200 0.441
14	8	6 (3)	SR3XT141FU	0.220 0.485

12 V  $\overline{\text{---}}$  power (via Zelio Logic SR3B261JD smart relay)

6	4	2	SR3XT61JD	0.125 0.276
10	6	4	SR3XT101JD	0.200 0.441
14	8	6 (3)	SR3XT141JD	0.220 0.485

24 V  $\overline{\text{---}}$  power supply (via Zelio Logic SR3B...BD smart relays)

6	4	2	SR3XT61BD	0.125 0.276
10	6	4	SR3XT101BD	0.200 0.441
14	8	6 (3)	SR3XT141BD	0.220 0.485

### Modem communication interface (4)

12...24 V  $\overline{\text{---}}$  power supply

Description	Reference
Modem communication interface	See page 32

(1) See page 22.

(2) See page 30.

(3) Including 4 outputs at maximum current of 8 A and 2 outputs at maximum current of 5 A.

(4) See page 32.

**Note:** The Zelio Logic smart relay and its associated extensions have an identical voltage to be able to operate together.

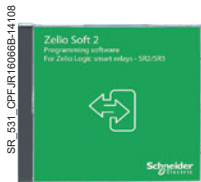

SR\_531\_CPF-IR16068B-14108

SR2SFT01



PA577329

HMISTO501



PF153902B

HMISTO705



SR\_531\_CPF-IR16063

SR2USB01



SR\_531\_CPF-IR16082B

SR2CBL09



SR\_531\_CPF-IR16058B

SR2BTC01



SR\_531\_CPF-IR16088

SR2MEM02

### Programming

Description	Use	Reference	Weight kg lb
<b>“Zelio Soft 2” software</b>			
<b>Programming software</b> “Zelio Soft 2”, multilingual, supplied on CD-ROM (1)	For PC and 32-bit and 64-bit operating systems compatible with Windows 7, 8.1, and 10	<b>SR2SFT01</b>	0.200 0.441

### HMI

<b>Magelis Small Panel with monochrome touch screen</b>	3.4" monochrome screen with 3 colors (green, orange, red) 16 MB application memory capacity Programmed using Vijeo Designer ≥ V6.0	<b>HMISTO501</b>	0.200 0.441
<b>Magelis Small Panel with color TFT touch screen</b>	4.3" color screen 26 MB application memory capacity Programmed using Vijeo XD	<b>HMISTO705 (2)</b>	0.220/ 0.485

### Connection accessories

<b>Connecting cables</b> Length: 3 m (9.84 ft.) For use with “Zelio Soft 2”	Between the PC (9-way SUB-D connector) and the Zelio Logic smart relay (programming port connector)	<b>SR2CBL01</b>	0.150 0.331
	Between the PC (USB connector) and the Zelio Logic smart relay (programming port connector)	<b>SR2USB01</b>	0.100 0.220
<b>Connecting cables</b> Length: 2.5 m (8.20 ft.)	Between the Magelis XBTN, XBTR, or XBTRT Small Panel (8-way mini-DIN connector) and the Zelio Logic smart relay (programming port connector)	<b>SR2CBL08</b>	0.100 0.220
	Between the Magelis HMISTO501 or HMISTO705 Small Panel (9-way removable screw terminal block) and the Zelio Logic smart relays (programming port connector)	<b>SR2CBL09</b>	-
<b>Bluetooth interface for Zelio Logic smart relays</b>	Between the PC (wireless link) and the Zelio Logic smart relay. Range of 10 m (32.80 ft.) (class 2)	<b>SR2BTC01</b>	0.015 0.033

### Memory cartridges (3)

<b>EEPROM memory cartridges</b>	For firmware (software embedded in the smart relay) version ≤ 2.4	<b>SR2MEM01</b>	0.010 0.022
	For firmware (software embedded in the smart relay) version ≥ 3.0	<b>SR2MEM02</b>	0.010 0.022

### Online documentation available

**User Manuals** for direct programming on the Zelio Logic smart relay (in English, French, German, Italian, Portuguese, or Spanish): please visit our website

### Regulated switch mode power supplies

Input voltage	Nominal output voltage	Reference
100...240 V ~ (50/60 Hz)	5 V $\overline{\text{---}}$ , 12 V $\overline{\text{---}}$ , or 24 V $\overline{\text{---}}$	Please refer to the product catalog (DIA3ED2170401EN) and visit our website

### Converters

Description	Reference
<b>Converters for J and K type thermocouples, for Pt100 probes, and voltage/current</b>	See page 38

(1) Also available as a free download from

(2) The SR2CBL09 cable used to connect an HMISTO705 terminal to a smart relay must be equipped with a shunt between the terminals marked CTS and RTS. This shunt is included on all cables leaving the factory after June 2017 (date code 1722).

(3) The use of memory cartridge SR2MEM02 to load the program is not compatible with the SR2COM01 modem communication interface.

# Zelio Logic - Smart relays

## Compact and modular smart relays

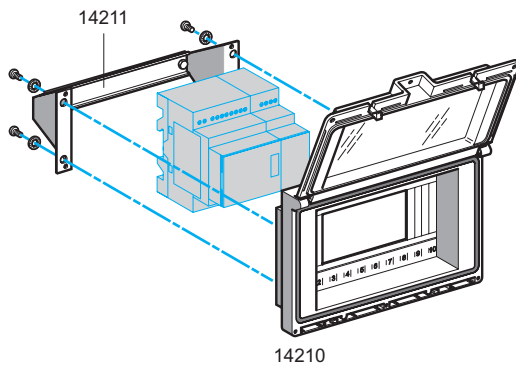

### Mounting accessories

Description/use	Mounting capacity	Reference	Weight kg lb
<b>Dust- and damp-proof enclosure</b> with split blanking plate arrangement, equipped with an IP 55 dust- and damp-proof window with hinged flap for mounting through a door	- 1 or 2 SR2 smart relays with 10 or 12 I/O	<b>14210</b>	0.350
	- or 1 SR2 smart relay with 20 I/O		0.772
	- or 1 SR3 smart relay with 10 I/O + 1 I/O extension with 6, 10, or 14 I/O		
	- or 1 SR3 smart relay with 26 I/O + 1 I/O extension with 6 I/O		
<b>Mounting bracket and symmetrical mounting rail</b>	For mounting enclosure <b>14210</b> through a door panel	<b>14211</b>	0.210 0.463

# Zelio Logic - Smart relays

## Communication

### Presentation

In order to communicate with their environment, Zelio Logic compact and modular smart relays and their extensions are equipped with various types of communication port.

- Compact and modular smart relays feature 1 serial link port for connecting a PC, the modem communication interface, a memory cartridge slot, or an HMI terminal. This port uses a dedicated Zelio Logic communication protocol.
- Zelio Logic modular smart relay extensions feature:
  - 1 RS 485 serial link port using the Modbus protocol on the **SR3MBU01BD** extension
  - 1 Ethernet Modbus/TCP 10/100 base T port on the **SR3NET01BD** extension

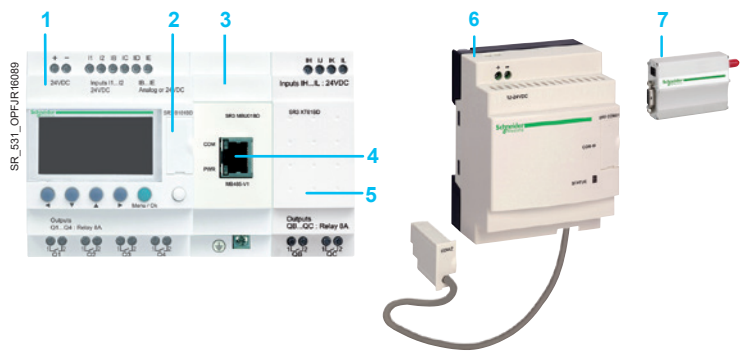

- 1 Modular smart relay (10 or 26 I/O)
- 2 Serial link port, Zelio Logic connector
- 3 Modbus slave or Ethernet server communication extension module
- 4 RJ45 connector for Modbus serial link or Ethernet Modbus/TCP network connection
- 5 Discrete (6, 10, or 14 I/O) or analog (4 I/O) I/O extension
- 6 Modem communication interface
- 7 GSM/UMTS modem

△ Observe the order of assembly above when using a Modbus serial link (slave) or Ethernet Modbus/TCP (server) network communication extension and a discrete or analog I/O extension. An I/O extension cannot be inserted before the Modbus serial link (slave) or Ethernet Modbus/TCP (server) network communication extension.

#### Communication ports on Zelio Logic smart relays and their extensions

	Smart relay serial link port	Modbus serial link port on SR3MBU01BD extension	Ethernet Modbus/TCP port on SR3NET01BD extension	Modem communication interface port
Smart relays	Physical layer			
	Proprietary	RS 485	10/100 base T	RS 232
	Connector			
	Zelio Logic	RJ45	RJ45	Dedicated Zelio
Compact	All types (connection and isolation via SR2CBL01 or SR2USB01 cable)	–	–	All SR2B●●●●●, SR2E●●●●● smart relays with clock (see page 32)
Modular	All types (connection and isolation via SR2CBL01 or SR2USB01 cable)	All SR3B●●●●BD smart relays with 24 V ~ power supply	All SR3B●●●●BD smart relays with 24 V ~ power supply	All types (see page 32)

### Description

#### Wired connection

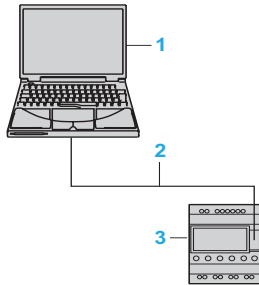

- 1 Programming PC
- 2 USB cable (SR2USB01) or serial link cable (SR2CBL01) (1)
- 3 Zelio Logic compact or modular smart relay

#### Wireless connection

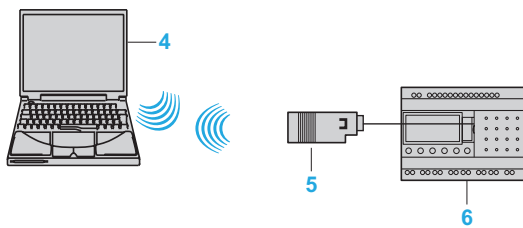

- 4 Programming PC with integrated Bluetooth technology (1)
- 5 Bluetooth interface (SR2BTC01) for Zelio Logic smart relay (1)
- 6 Zelio Logic compact or modular smart relay

#### Modem link

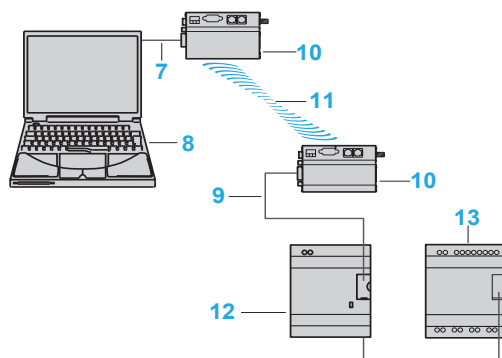

- 7 PC-modem connecting cable (SR1CBL03)
- 8 Programming PC
- 9 Modem interface connecting cable included with SR2COM01(1)
- 10 Data transmission/reception modem (SR2MOD02) (1)
- 11 Phone or radio link
- 12 Communication interface (SR2COM01)
- 13 Zelio Logic compact or modular smart relay

(1) See page 20.



Modbus serial link network communication extension

### Presentation

The Modbus communication protocol is the master/slave type.

Two exchange methods are possible:

- Request/response:
  - The request from the master is addressed to a specific slave.
  - The response is expected by return from the polled slave.
- Broadcast:
  - The master broadcasts a request to all slave stations on the bus. These stations execute the command without transmitting a response.

Zelio Logic modular smart relays are connected to the Modbus network via the Modbus slave network communication extension. This extension is a slave that is not electrically isolated.

The Modbus slave network communication extension must be connected to an SR3B...BD modular smart relay with a 24 V  $\square$  power supply.

### Configuration

The Modbus slave network communication extension can be configured:

- locally, using the buttons on the smart relay (1)
- on a PC using "Zelio Soft 2" software (see page 10)

When using a PC, programming can be performed either in ladder language or in function block diagram (FBD) language (see page 12).

### Description

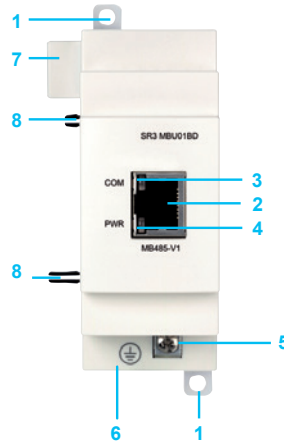

The Modbus slave network communication extension **SR3MBU01BD** comprises:

- 1 Two retractable mounting lugs
- 2 A Modbus network connection (RJ45 shielded female connector)
- 3 A communication LED (COM)
- 4 A power LED (PWR)
- 5 A screw terminal block for the protective ground connection
- 6 Spring for clip-on mounting on a 35 mm / 1.38 in rail
- 7 Connector for connection to the Zelio Logic smart relay (powered via the Zelio Logic smart relay)
- 8 Locating pegs

(1) Programming via the buttons on the front panel of the smart relay is only possible in ladder language.

## Zelio Logic - Smart relays

### Communication

#### Modbus serial link communication protocol

#### Connection examples

##### Example 1

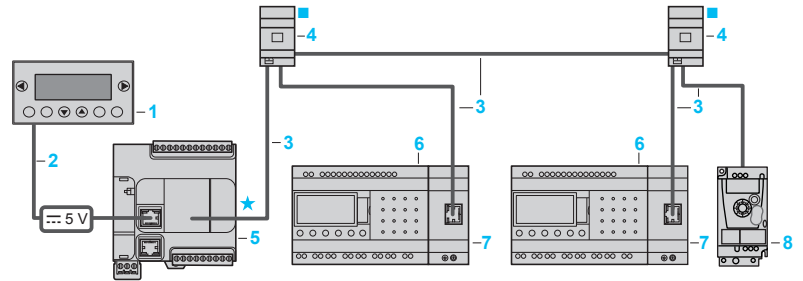

- Total length of cables between M221 and Altivar 12:  $\leq 30$  m (98.43 ft)

- Length of cable 3:  $\leq 10$  m (32.81 ft)

★ Line polarization active ■ Line terminator

- 1 Slave display unit **XBTN401**
- 2 Controller to Magelis HMI cordsets
- 3 Modbus RS485 cordsets (**VW3A8306R** extension cables)
- 4 Junction box **TWDXCAT3RJ** (1 x RJ45 for trunk cable, 2 x RJ45 for drop)
- 5 Modicon master logic controller **TM221C** equipped with communication cartridge **TMC2SL1** (1)
- 6 Modular smart relay **SR3B**
- 7 Modbus communication extension module **SR3MBU01BD**
- 8 Altivar 12 drive

(1) Polarization must be enabled in the Modicon M221 master.

##### Example 2

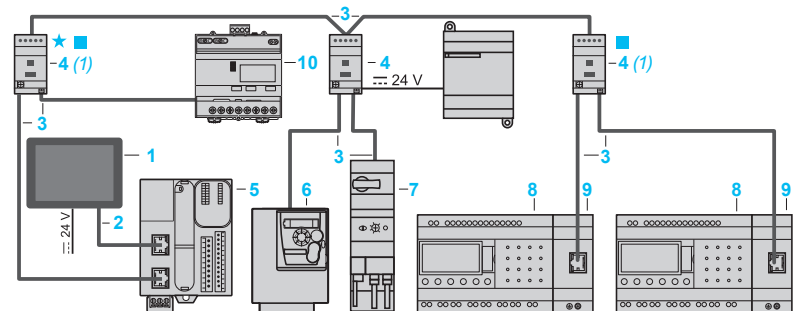

- Total length of cables between isolation boxes 4:  $\leq 1,000$  m (3,281 ft.)

- Length of drop cables 3:  $\leq 10$  m (32.81 ft.)

★ Line polarization active ■ Line terminator

- 1 Master display unit **HMISCU**
- 2 Controller to Magelis HMI cordsets
- 3 Modbus RS485 cordsets (**VW3A8306R** extension cables)
- 4 Serial link tap isolation box **TWDXCAISO** (1 x RJ45 for trunk cable, 2 x RJ45 for drop)
- 5 Modicon master logic controller **TM221M** (2)
- 6 Altivar 312 variable speed drive
- 7 TeSys U motor starter controller
- 8 Modular smart relay **SR3B**
- 9 Modbus communication extension module **SR3MBU01BD**
- 10 Power meter **IEM31**

(1) Box powered by the logic controller

(2) Network master connected to serial link port (SERIAL1)

#### Function description

- The Modbus slave network communication extension is connected to a 2-wire or 4-wire Modbus network (1).
- The maximum length between 2 **TWDXCAISO** taps configured as line terminators is 1,000 m/3,281 ft (9600 baud max., AWG 26).
- A maximum of 32 slaves can be connected to the Modbus network, or a maximum of 247 slaves with repeaters.
- The connection cable and its RJ45 male connectors must be shielded.
- The module  $\perp$  terminal must be connected directly to the protective ground.

(1) Refer to the Quick Reference Guide supplied with the product.

# Zelio Logic - Smart relays

## Communication

### Modbus serial link communication protocol

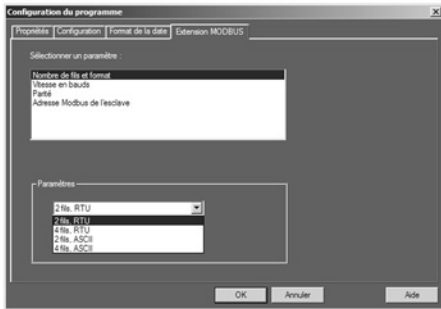

Software workshop parameter entry window

#### Parameter entry

Parameters can be entered either using “Zelio Soft 2” software, or directly using the buttons on the Zelio Logic smart relay (1).

When the “RUN” command is issued, the Zelio Logic smart relay initializes the Modbus slave network communication extension in a configuration previously defined in the basic program.

The Modbus slave network communication extension has 4 parameters:

- number of UART wires and Modbus frame format
- transmission speed
- parity
- Modbus extension network address

The default parameter settings are as follows: 2-wire, RTU, 19,200 baud, even parity, address 1.

Parameters	Options
Number of wires	2 or 4
Frame format	RTU or ASCII
Transmission speed (baud)	1200, 2400, 4800, 9600, 19,200, 28,800, 38,400, 57,600
Parity	None, even, odd
Network address	1 to 247

#### Addressing Modbus exchanges

##### Ladder programming

In ladder mode, the 4 data words (16 bits) to be exchanged cannot be accessed by the application. Transfers with the master are implicit and are carried out in a way that is totally transparent.

Modbus exchanges	Code	Number of words
Image of smart relay I/O	Read 03	4
Clock words 	Read/Write 16, 06, or 03	4
Status words	Read 03	1

##### Function block diagram (FBD) programming

In FBD mode, the 4 input data words (16 bits) (J1XT1 to J4XT1) and the 4 output data words (O1XT1 to O4XT1) can be accessed by the application. Conversion function blocks are used to:

- break down a word type input (16 bits) into 16 separate “bit” type outputs using the CAN (analog-to-digital conversion) function e.g. to break down a J1XT1 to J4XT1 type input and copy these status values to discrete outputs
- compose a word type output (16 bits) from 16 separate “bit” type outputs using the CNA (digital-to-analog conversion) function e.g. to transfer the status value of discrete inputs or the status of a function to an O1XT1 to O4XT1 type output

Modbus exchanges	Code	Number of words
Input words	Read/Write 16, 06, or 03	4
Output words	Read 03	4
Clock words 	Read/Write 16, 06, or 03	4
Status words	Read 03	1

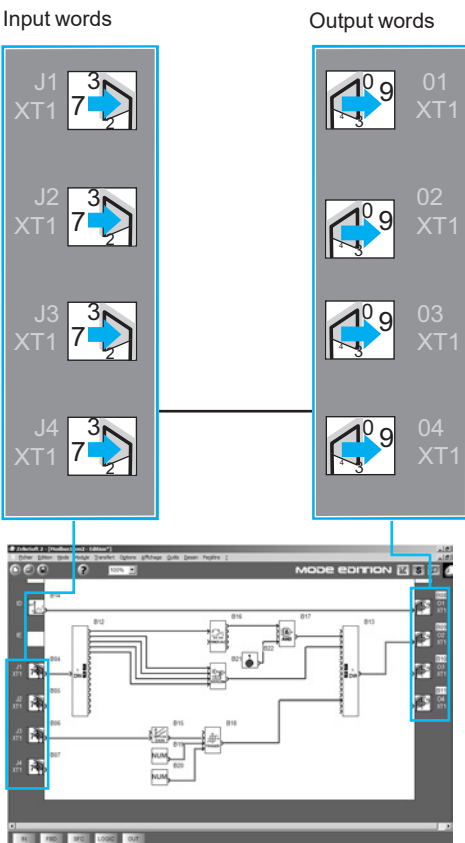

FBD program editing window

(1) Programming via the buttons on the front panel of the smart relay is only possible in ladder language.



Ethernet (server) network communication extension

#### Presentation

The **SR3NET01BD** extension is used to communicate over Ethernet via the Modbus/TCP protocol in server mode. It must be connected to an **SR3B●●●BD** smart relay with a 24 V  $\bar{\text{---}}$  power supply.

#### Configuration

The extension is configured on a PC using “Zelio Soft 2” software (see page 10). Programming on the PC is performed in function block diagram (FBD) language (see page 12).

#### Description

The Ethernet Modbus/TCP network communication extension **SR3NET01BD** comprises:

- |  |   |
|--|---|
|  | <ol style="list-style-type: none"> <li>1 Two retractable mounting lugs</li> <li>2 An Ethernet network connection (RJ45 shielded female connector)</li> <li>3 A communication LED (LK/ACT 10/100)</li> <li>4 A status LED (STS)</li> <li>5 A screw terminal block for the protective ground connection</li> <li>6 Spring for clip-on mounting on a 35 mm/1.38 in rail</li> <li>7 Connector for connection to the Zelio Logic smart relay (powered via the Zelio Logic smart relay)</li> <li>8 Locating pegs</li> </ol> |
|--|---|

#### Connection example

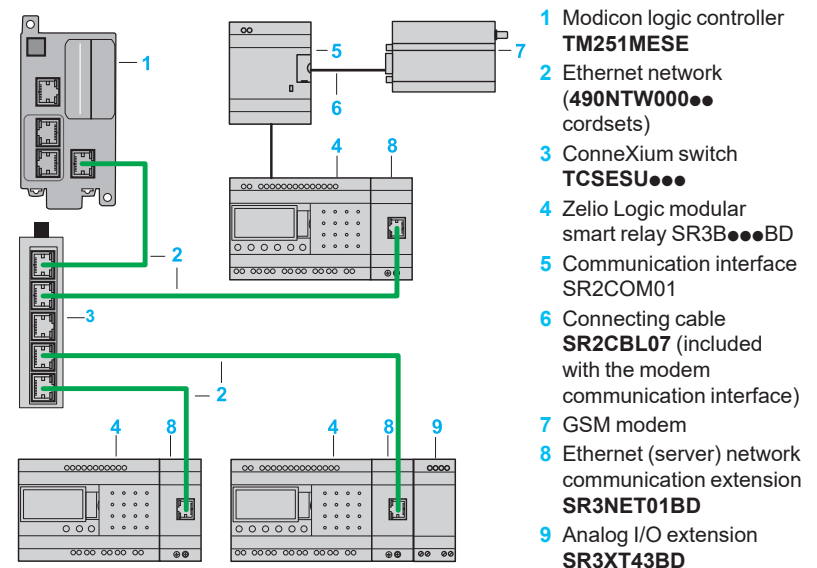

#### Function description

- The Ethernet Modbus/TCP network communication extension is connected to a LAN.
- The maximum cable length between 2 devices is 100 m/328.08 ft.
- The connection cable must be at least category 5, and its RJ45 male connectors must be shielded.
- The  $\bar{\text{---}}$  terminal must be connected directly to the protective ground.



Ethernet extension configuration window

### Parameter entry

Parameters can be entered using “Zelio Soft 2” software. When the “RUN” command is issued, the Zelio Logic smart relay initializes the Ethernet Modbus/TCP network communication extension in a configuration previously defined in the basic program.

The Ethernet Modbus/TCP network communication extension has 6 parameters:

- type of addressing (dynamic or static)
- IP address
- subnet mask
- gateway address
- reserved address
- time out

### Addressing Ethernet exchanges

#### Function block diagram (FBD) programming

In FBD mode, the 4 input data words (16 bits) (J1XT1 to J4XT1) and the 4 output data words (O1XT1 to O4XT1) can be accessed by the application.

Conversion function blocks are used to:

- break down a word type input (16 bits) into 16 separate “bit” type outputs using the CAN (analog-to-digital conversion) function e.g. to break down a J1XT1 to J4XT1 type input and copy these status values to discrete outputs
- compose a word type output (16 bits) from 16 separate “bit” type outputs using the CNA (digital-to-analog conversion) function e.g. to transfer the status value of discrete inputs or the status of a function to an O1XT1 to O4XT1 type output

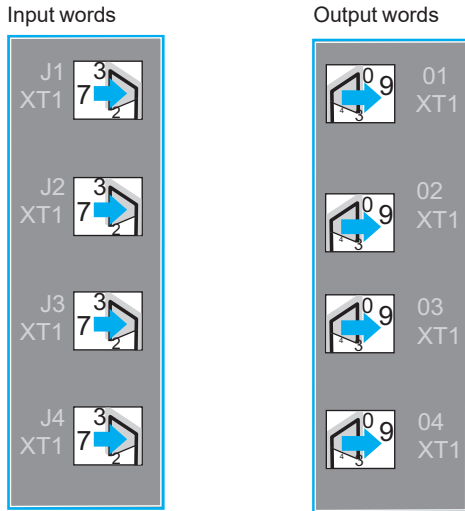

Ethernet exchanges	Code	Number of words
Input words	Read/Write 16, 06, or 03	4
Output words	Read 03	4
Clock words	Read/Write 16, 06, or 03	4
Status words	Read 03	1

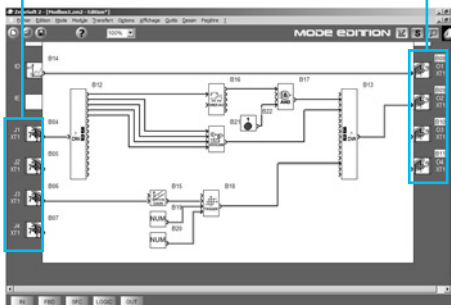

FBD program editing window



SR3MBU01BD



SR3NET01BD



TWDXCAT3RJ



TWDXCAISO

### Modbus serial link and Ethernet Modbus/TCP network communication extensions

For use with	Communication ports	Reference	Weight kg lb
SR3B●●1BD and SR3B●●2BD modular smart relays	Serial link (RJ45)	SR3MBU01BD	0.110 0.242
	Ethernet (RJ45)	SR3NET01BD (1)	0.110 0.242

### Connection accessories

Designation	Description	Network	Length m/ft	Reference	Weight kg lb
T-junctions	<input type="checkbox"/> 2 x RJ45 connectors <input type="checkbox"/> 1 integrated cable with RJ45 connector	Modbus serial link	0.3/0.98	VW3A8306TF03	0.190 0.418
			1/3.28	VW3A8306TF10	0.210 0.462
			Without cable	170XTS04100	0.020 0.044
Junction boxes	<input type="checkbox"/> Screw terminal block for trunk cable <input type="checkbox"/> 2 x RJ45 connectors for tap link <input type="checkbox"/> Isolation of RS 485 serial link <input type="checkbox"/> Polarization and line termination <input type="checkbox"/> 24 V $\overline{\text{DC}}$ power supply <input type="checkbox"/> Mounting on $\overline{\text{C}}$ rail (35 mm/1.38 in.)	Modbus serial link	–	TWDXCAISO	0.100 0.220
			–	TWDXCAT3RJ	0.080 0.176
Line terminator	<input type="checkbox"/> For RJ45 connector <input type="checkbox"/> R = 120 $\Omega$ , C = 1 nF	Modbus serial link	–	VW3A8306RC	0.200 0.440
			–		
RS 485 extension cables	<input type="checkbox"/> 2 x RJ45 connectors	Modbus serial link	0.3/0.98	VW3A8306R03	0.030 0.066
			1/3.28	VW3A8306R10	0.050 0.110
			3/9.84	VW3A8306R30	0.150 0.330
RS 485 double shielded twisted pair trunk cables	<input type="checkbox"/> Modbus serial link, supplied without connector	Modbus serial link	100/328.08	TSXCSA100	5.680 12.52
			200/656.17	TSXCSA200	10.920 24.074
			500/640.42	TSXCSA500	30.00 66.13
Straight-through shielded twisted pair extension cables	<input type="checkbox"/> 2 x RJ45 connectors	Ethernet Modbus/TCP	2/6.56	490NTW00002 (2)	–
			5/16.40	490NTW00005 (2)	–
			12/39.37	490NTW00012 (2)	–
			40/131.23	490NTW00040 (2)	–
			80/262.47	490NTW00080 (2)	–

(1) Can only be used in FBD language.

(2) Cable compliant with EIA/TIA-568 standard category 5 and IEC 1180/EN 50173 class D.  
For UL and CSA 22.1 approved cables, add the letter U at the end of the reference.



Analog I/O extension

### Presentation

#### Modular smart relays and analog I/O extensions

To improve performance and flexibility, Zelio Logic modular smart relays can take analog I/O extensions with 10-bit resolution. The inputs accept 0-10 V, 0-20 mA, and Pt 100 signals.

Using a Zelio Logic modular smart relay with a 24 V  $\overline{\text{DC}}$  power supply in conjunction with an analog 4 I/O extension makes it possible to obtain up to 30 I/O, including 8 analog inputs and 2 analog outputs.

The analog I/O extension works with SR3●●●BD smart relays with a 24 V  $\overline{\text{DC}}$  power supply.

### Description



The analog I/O extension front panel comprises:

- 1 Two retractable mounting feet
- 2 Terminals for connecting the inputs
- 3 Terminals for connecting the outputs
- 4 Connector for connection to the smart relay (powered via the smart relay)
- 5 Locating pegs

### Combination of modular smart relays and extensions



- 1 Modular smart relay (10 or 26 I/O)
- 2 Analog I/O extension (4 I/O)

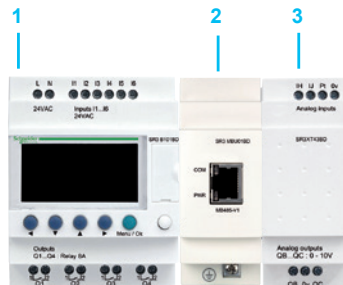

- 1 Modular smart relay (10 or 26 I/O)
- 2 Modbus serial link or Ethernet Modbus/TCP network communication extensions
- 3 Analog I/O extension (4 I/O)

$\Delta$  Observe the order of assembly above when using a network communication module and an analog I/O extension. An I/O extension cannot be inserted before the network communication extension.



SR3XT43BD

### Analog I/O extension

24 V  $\overline{\text{---}}$  power supply (via SR3B●●BD smart relays)

Number of I/O	Number of inputs	Including 0 - 10 V	Including 0 - 20 mA	Including Pt100	0 - 10 V output	Reference	Weight kg /lb
4	2	2 max.	2 max.	1 max.	2	SR3XT43BD (1)	0.110 0.243

(1) Can only be used in FBD language.

# Zelio Logic - Smart relays

## Modem communication interface



Modem communication interface



GSM/UMTS modem (1)

### Presentation

The communication products in the Zelio Logic range are primarily designed for monitoring or remote control of machines or installations which operate without personnel.

Examples:

- monitoring of lift pumps, livestock buildings (ventilation, feed level, etc.), refrigeration units, car washes
- alarm in the event of failure of industrial or domestic heating boilers
- remote control of lighting: parking lots, warehouses
- remote control and monitoring of escalators, public transport
- refuse compactor full alert

The communication range comprises:

- a communication interface connected between a smart relay and a modem
- A GSM/UMTS modem (1)
- "Zelio Logic Alarm" software

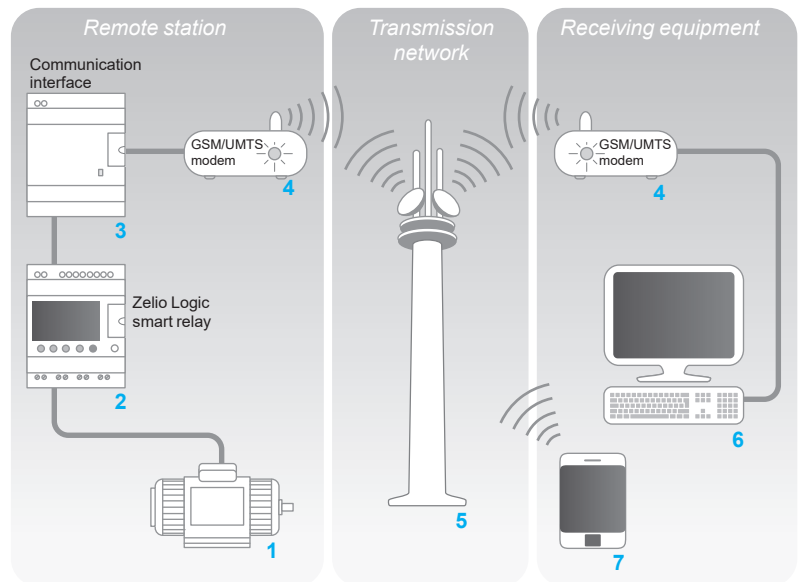

The system comprises:

- A *remote station*, machine, or installation to be monitored **1**: control is achieved using a Zelio Logic smart relay with clock from the SR●B●●●●● or SR2E●●●●● range **2** via its inputs and outputs. The smart relay is connected via a communication interface **3** to a GSM/UMTS modem (1) **4**.
- The GSM/UMTS telephone *transmission network* **5** provided by different telecommunications operators
- A monitoring or control *receiver device*, which may be either of the following:
  - a PC **6** equipped with a GSM/UMTS modem
  - A GSM/UMTS phone **7**

**Note:** The majority of modems built into PCs can be used.

Various combinations are possible between the types of modem used on the *Remote station*, the type of *receiver device* (PC + modems or phone), and the type of GSM/UMTS network available.

The type of architecture selected will therefore mainly depend on whether there is a need to send SMS messages or not (see page 35).

(1) GSM = Global System Mobile (2G). UMTS = Universal Mobile Telecommunications System (3G). The versions of modem communicating on the UMTS network (3G) are reserved for certain countries. Please contact our Customer Care Center.

### Presentation (continued)

#### Smart relay (*remote station*)

The smart relay, as on an independent machine or installation, is used for control (1). It contains the application program created using "Zelio Soft 2".

The smart relay can be selected from the various models in the Zelio Logic range:

- according to the supply voltage
- with 10, 12, 20, or 26 I/O (up to 40 I/O with discrete extension)
- with or without display
- with clock

#### Modem communication interface (*remote station*)

The modem communication interface allows messages, phone numbers, and calling conditions to be stored.

When the calling conditions are met, the messages, as well as any values to be sent, are date-stamped and stored in the interface.

The modem communication interface scales analog values to the physical values (degrees, bar, Pascal, etc.) required by the user.

#### Modem GSM/UMTS

GSM or UMTS modems can both be used on the *remote station* and PC type *receiver device* (if the PC is not equipped with an internal modem). This modem automatically adapts to the available network, by prioritizing the GSM network, which offers the greatest functionality. If there is only a UMTS network available, there will be reduced functionality (see the table on page 35).

In order to exploit all the capabilities associated with the communication modem, the modems are equipped with DATA type SIM cards. VOICE type SIM cards may also be used but some functions will not be available (see the table on page 35).

#### "Zelio Logic Alarm" alarm management software (*PC type receiver device*)

This software is used to:

- receive, classify, and export diagnostic alarm messages
- read or remotely force the status of program elements (inputs, outputs, auxiliary relays, timer or counter values, etc.)
- send control instructions (RUN, STOP, setting the time of the smart relay, etc.)
- send specific instructions (modifying access rights, recipients, etc.)

*Note: This software can only be used on GSM networks (2G).*

(1) Zelio Logic smart relays (see page 8)

### Description

The SR2COM01 modem communication interface comprises:

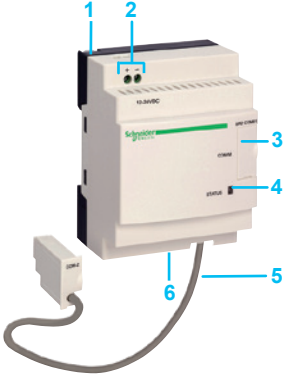
- 
- 1 Retractable mounting lugs
  - 2 12...24 V  $\overline{\text{DC}}$  power supply terminal block
  - 3 Slot for connection to modem or PC
  - 4 Interface status LED indicator
  - 5 Connection cable to the smart relay
  - 6 Spring for clip-on mounting on a 35 mm (1.38 in.) rail

### Functions

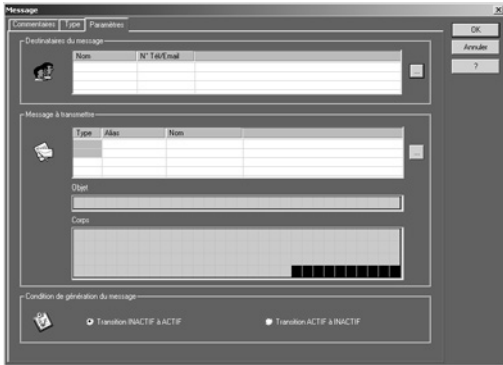

Message parameter entry window

#### Sending alarms

This function is used to send an alarm message to a *receiver device*. When the calling condition is met, a message is sent to one or several phone numbers or e-mail addresses.

Types of message:

- alarm message on a PC with modem and “Zelio Logic Alarm” software
- “SMS” message (1) on a GSM/UMTS phone
- e-mail via SMS (1) (2)

One or all of these solutions can be selected simultaneously.

The *remote station* to be monitored initiates the call.

The phone line is only used while the alarm message is being transmitted.

Up to 28 messages can be used.

These messages consist of:

- a 160-character text, which may contain discrete and/or analog values (counter values, analog input voltages that can be scaled, etc.)
- 1 to 10 recipient phone numbers/e-mail addresses

#### Receiving commands

This function allows the status or the value of a program element to be modified from the *receiver device*.

The operator initiates the call using the *receiver device* (PC or phone). It is then possible to force the status of the discrete and/or analog value of each of the 28 messages.

#### Remote dialog using “Zelio Soft 2”

This function enables use of the Transfer, Monitoring, and Diagnostics modes available in “Zelio Soft 2” via the *transmission network* instead of via the physical link (SR2USB01 or SR2CBL01 cable) between the device (*remote station*) and the PC (*receiver device*).

It is then possible to:

- transfer a program created on a PC station to the *remote station*
- transfer a program installed on the *remote station* to the PC station
- modify the receiver device phone numbers/e-mail addresses and the alarm sending conditions from the PC
- update the firmware for the smart relay and the modem communication interface
- display and modify discrete and analog values
- perform diagnostics on the smart relay and modem communication interface

(1) Requires the use of a GSM/UMTS modem on the remote station side.

(2) Check with the transmission network operator that the e-mail by SMS service is available.

### Functions available depending on the hardware architecture and/or type of SIM card

Function	Remote station device				
	GSM network (2G)				
	Type of SIM card				
	DATA	DATA VOICE		VOICE	
	DATA No.	VOICE No.		UMTS network (3G)	
Send alarm/receive command with GSM/UMTS phone					
Send alarm/receive command with PC equipped with “Zelio Logic Alarm” software (1)					
Program transfer, firmware update, monitoring (1)					
Send alarm via e-mail					

Functions available

Functions not available

**Note:** Commands cannot be sent by e-mail.

(1) When using a GSM/UMTS modem on the PC side, it is essential that the SIM card has a DATA number.

### Installation setup

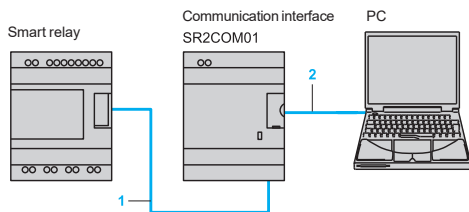

There are 2 steps involved in setting up the installation or machine to be monitored:

#### Connection for programming the smart relay and interface

- 1 Interface cable marked COM-Z
- 2 SR2USB01 or SR2CBL01 cable

After having powered-up the smart relay and the interface, the application program can be transferred in order to simultaneously:

- load the automation system program into the smart relay
- load the alarm conditions, messages, and phone numbers into the interface

This operation can also be carried out remotely using "Transfer" mode, after having established the connections described below.

△ The use of memory cartridge SR2MEM01 or SR2MEM02 to load the program is not compatible with the SR2COM01 modem communication interface.

#### Connections for operation

- 1 Interface cable marked COM-Z
- 2 SR2CBL07 cable supplied with the interface
- 3 Antenna included with modem

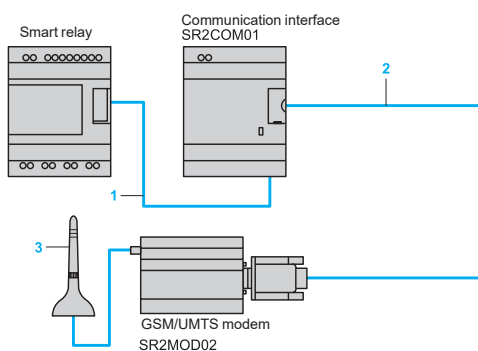

### References



SR2COM01



SR2MOD02



SR2CBL07

#### Modem communication interface

Description	For use with	Power supply	Reference	Weight kg/lb
Modem communication interface (including SR2CBL07 cable)	SR●B●●●●●, SR2E●●●●●	12...24 V ~	SR2COM01	0.200 0.441

#### Modem

Description	Supply voltage	Reference	Weight kg/lb
GSM/UMTS modem (1) including:	12...24 V ~	SR2MOD02 (2)	0.335 0.739
□ power supply cable (1.5 m/4.92 ft)			
□ antenna with cable (2.5 m/8.20 ft)			
□ mounting on 15-rail (assembled with GSM/UMTS modem)			
□ 2 lugs for plate mounting			

#### Software

Description	Use Compatibility	Media	Reference	Weight kg/lb
Zelio Logic Alarm	For PC and 32-bit and 64-bit operating systems compatible with Windows 7, 8.1, and 10	CD-ROM	SR2SFT02	0.200 0.441

#### Connection accessories

Description	Composition/Use	Length m/ft	Reference	Weight kg/lb
Connecting cables	9-way SUB-D/9-way SUB-D connectors Between modem and PC	1.80/5.90	SR1CBL03	0.110 0.243
	Special Zelio/9-way SUB-D connector Between communication interface and modem	0.50/1.64	SR2CBL07 (3)	0.050 0.110

(1) Global System Mobile (2G)/Universal Mobile Telecommunications System (3G). The versions of modem communicating on the UMTS network (3G) are reserved for certain countries. Please contact our Customer Care Center.

(2) Not recommended for Japan.

(3) Spare part (cable included as standard with SR2COM01 communication interface).

# Analogue interfaces - Zelio Analog

Converters for thermocouples and Pt100 probes  
Voltage/current converters

Product types		Converters for thermocouples				
						
<b>Input type</b>		J (Fe-CuNi)		K (Ni-CrNi)		
<b>Input signal</b>	<b>Temperature range</b>	0...150 °C	0...300 °C	0...600 °C	0... 600 °C	0...1200 °C
		32...302 °F	32...572 °F	32...1112 °F	32...1112 °F	32...2192 °F
	<b>Voltage</b>	-				
	<b>Current</b>	-				
<b>Output signal</b>	<b>Voltage/Current</b>	Switchable: 0...10 V / 0...20 mA; 4...20 mA				
<b>Supply voltage</b>	<b>Rated</b>	~ 24V ± 20%, not isolated				
<b>Built-in protection</b>	<b>Outputs</b>	Reverse polarity, overvoltage and short-circuit Output safety feature, if input not wired or wire broken				
	<b>Supply</b>	Reverse polarity				
<b>Signalling</b>		Green LED (power on)				
<b>Conformity/Approvals</b>	<b>Conforming to standards</b>	IEC 60947-1, IEC 60584-1				
	<b>Approvals</b>	UL, CSA, GL, CE				
<b>Type</b>		<b>RMTJ40BD</b>	<b>RMTJ60BD</b>	<b>RMTJ80BD</b>	<b>RMTK80BD</b>	<b>RMTK90BD</b>
<b>Pages</b>		40				

Converters for Universal and Optimum Pt100 probes					Voltage/current converters				
									
<b>Pt100, 2, 3 et 4 fils</b>					-				
-40...40 °C	-100...100 °C	0...100 °C	0...250 °C	0...500 °C	-				
-40...104 °F	-148...212 °F	32...212 °F	32...482 °F	32...932 °F	-				
-					0...10 V	0...10 V; ± 10 V	0...50 V 0...300 V 0...500 V ~ or ~ 50/60 Hz	-	
-					4...20 mA	0...20 mA 4...20 mA	-	0...1.5 A 0...5 A 0...15 A ~ or ~ 50/60 Hz	
Switchable: 0...10 V/0...20 mA, 4...20 mA for Universal range <b>RMPT•0BD</b> 0...10 V ou 4...20 mA for Optimum range <b>RMPT•3BD</b>					0...10 V or 4...20 mA	Switchable: 0...10 V ±10 V/0...20 mA 4...20 mA	Switchable: 0...10 V/4...20 mA 0...20 mA	0...10 V or 0...20 mA or 4...20 mA	
~ 24 V ± 20 %, non isolé					~ 24 V ± 20 %, isolé				
Reverse polarity, overvoltage and short-circuit Output safety feature, if input not wired or wire broken					Reverse polarity, overvoltage and short-circuit Output safety feature, if input not wired or wire broken				
Reverse polarity					Reverse polarity				
Green LED (power on)					Green LED (power on)				
IEC 60751, DIN 43 760					IEC 60947-1				
UL, CSA, GL, CE					UL, CSA, GL, CE				
<b>RMPT10BD, RMPT13BD</b>	<b>RMPT20BD, RMPT23BD</b>	<b>RMPT30BD, RMPT33BD</b>	<b>RMPT50BD, RMPT53BD</b>	<b>RMPT70BD, RMPT73BD</b>	<b>RMCN22BD</b>	<b>RMCL55BD</b>	<b>RMCV60BD</b>	<b>RMCA61BD</b>	
40 and 41									

# Analogue interfaces - Zelio Analog

## Converters for thermocouples and Pt100 probes

### Voltage/current converters

The Zelio Analog range of converters is designed to convert signals emitted by sensors or electrical measurements into standard electrical signals which are compatible with automation platforms, controllers (thermal processes, speed, ...). They also allow the connection distance between a sensor and the measurement acquisition device to be increased: for example between a thermocouple and a programmable controller.

Conforming to IEC standards, UL and CSA certified, these converters are suitable for universal use.

#### Measurement signals for thermocouples and Pt100 probes

The voltages induced by thermocouples vary between 10 and 80  $\mu\text{V}/^\circ\text{C}$ , Pt100 probes (100 ohms at 0  $^\circ\text{C}$ ) produce about 0.5  $\text{mV}/^\circ\text{C}$ , with measurement currents of 1 mA. Depending on the sensor, the signal to be measured ranges from a few  $\mu\text{V}$  (thermocouple) to 250 and 700 mV for a Pt100 probe.

It is therefore difficult to transmit these low level signals over long electric lines without encountering problems of interference, signal reduction or errors.

Connecting Zelio Analog converters close to the sensors resolves these problems :

- 4-20 mA current loops transmitted over a long distance are less sensitive to interference than low level voltage signals from sensors,
- signal reductions during transmission (resistance) of voltages do not occur,
- the cables used to connect the converters to process equipment (programmable controllers) are standard cables, which are more cost effective than extension cables or compensation cables suitable for low level signals for Pt100 probes or thermocouples.

### Presentation

#### The Zelio Analog range

The Zelio Analog range has been developed both to take account of the most common applications and to ensure great simplicity of installation:

- pre-set input and output scales, requiring no adjustment
- outputs protected against reverse polarity, overvoltage and short-circuits
- $\approx$  24 V power supply
- sealable protective cover
- rail mounting and screw fixing onto mounting plate
- LED indicator on the front panel
- input and output selector switches on the front panel
- output with fallback value if no input signal is present (due to failure of a sensor, for example).

The Zelio Analog converter range is divided into four families:

- Converters for J and K type thermocouples: **RMTJ/K**
- Universal converters for Pt100 probes: **RMPT●0**
- Optimum converters for Pt100 probes: **RMPT●3**
- Universal voltage/current converters: **RMC**.

#### Converters for J and K type thermocouples

Thermocouples, which consist of two metals with different thermo-electric characteristics, produce a voltage that varies according to temperature. This voltage is transmitted to the Zelio Analog converter which converts it to a standard signal.

Converters for thermocouples have cold junction compensation to allow detection of measurement errors induced by the connection to the device itself.

Converters for J and K type thermocouples have:

- for inputs, a pre-set temperature range, depending on the model:
  - Type J: 0...150  $^\circ\text{C}$ , 0...300  $^\circ\text{C}$ , 0...600  $^\circ\text{C}$
  - Type K: 0...600  $^\circ\text{C}$ , 0...1200  $^\circ\text{C}$ .
- for outputs, a switchable signal:
  - 0...10 V, 0... 20 mA, 4... 20 mA.



RMTJ/K



RMPT●0



RMPT●3



RMC

# Analogue interfaces - Zelio Analog

## Converters for thermocouples and Pt100 probes

### Voltage/current converter



RMPT70BD

#### Universal converters for Pt100 probes

Pt100 probes with platinum resistor are electrical conductors whose resistance varies according to the temperature.

This ohmic resistance is transmitted to the Zelio Analog converter which converts it to a standard signal.

Universal converters for Pt100 probes have :

■ for inputs, a pre-set temperature range, depending on the model:

- -100...100 °C,
- -40...40 °C,
- 0...100 °C,
- 0...250 °C,
- 0...500 °C.

■ for outputs, a switchable signal:

- 0... 10 V, 0... 20 mA, 4... 20 mA.

The products in the family Universal converters for Pt100 probes allow wiring of Pt100 probes in 2, 3 and 4-wire mode.

#### Optimum converters for Pt100 probes

Derived from the above family, these converters have:

■ for inputs, a pre-set temperature range identical to that of universal converters for Pt100 probes.

■ for outputs: 0...10V signal dedicated to Zelio Logic analogue inputs.

They allow Pt100 probes to be wired in 2, 3 and 4-wire mode.



RMCA61BD

#### Universal voltage/current converters

This family of converters allows the adaptation of electrical values (voltage/current). Four products are available:

■ a cost effective converter which will convert a 0...10 V signal to a 4...20mA signal or vice versa.

■ a Universal voltage/current converter allowing the most common signals. They have:

□ for inputs, a voltage/current range:

- 0...10 V, ± 10 V, 0...20 mA, 4...20 mA.

□ for outputs, a switchable voltage/current range:

- 0...10 V, ± 10 V, 0...20 mA, 4...20 mA.

■ two Universal voltage/current converters which allow conversion of electrical power signals, both a.c. and d.c.

They have the following, depending on the model:

□ **for voltage inputs**, a range of 0 to 500 V (~ or ---)

□ for outputs, a switchable voltage/current range:

- 0...10 V, 0...20 mA, 4...20 mA.

□ **for current inputs**, a range of 0 to 15 A (~ or ---)

□ for outputs, a voltage/current range:

- 0...10 V, 0...20 mA, 4...20 mA.

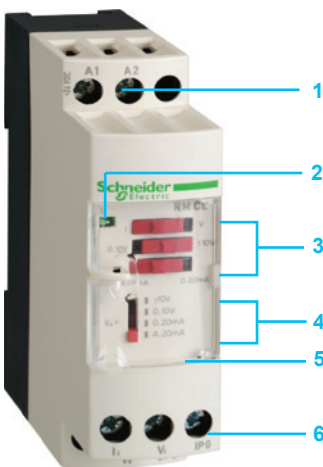

RMCL55BD

#### Description

Zelio Analog converters have the following on their front panel, depending on the model:

- 1 Two terminals for --- 24 V supply connection
- 2 A 'Power ON' LED
- 3 Three input selector switches (depending on model)
- 4 An output selector switch (depending on model)
- 5 A sealable protective cover
- 6 A screw terminal block for inputs
- 7 A screw terminal block for outputs

# Analogue interfaces - Zelio Analog

## Converters for thermocouples and Pt100 probes

### Voltage/current converters



RMTJ40BD



RMTK90BD



RMPT70BD



RMPT13BD

#### Converters for J and K type thermocouples

Supply voltage  $\approx 24\text{ V} \pm 20\%$ , non isolated

Type	Temperature range		Switchable output signal	Reference	Weight kg lb
	°C	°F			
Type J	0...150	32...302	0...10 V, 0...20 mA, 4...20 mA	RMTJ40BD	0.120 0.264
	0...300	32...572	0...10 V, 0...20 mA, 4...20 mA	RMTJ60BD	0.120 0.264
	0...600	32...1112	0...10 V, 0...20 mA, 4...20 mA	RMTJ80BD	0.120 0.264
Type K	0...600	32...1112	0...10 V, 0...20 mA, 4...20 mA	RMTK80BD	0.120 0.264
	0...1200	32...2192	0...10 V, 0...20 mA, 4...20 mA	RMTK90BD	0.120 0.264

#### Universal converters for Pt100 probes

Supply voltage  $\approx 24\text{ V} \pm 20\%$ , non isolated

Type	Temperature range		Switchable output signal	Reference	Weight kg lb
	°C	°F			
Pt100 2-wire, 3-wire and 4-wire	-40...40	-40...104	0...10 V, 0...20 mA, 4...20 mA	RMPT10BD	0.120 0.264
	-100...100	-148...212	0...10 V, 0...20 mA, 4...20 mA	RMPT20BD	0.120 0.264
	0...100	32...212	0...10 V, 0...20 mA, 4...20 mA	RMPT30BD	0.120 0.264
	0...250	32...482	0...10 V, 0...20 mA, 4...20 mA	RMPT50BD	0.120 0.264
	0...500	32...932	0...10 V, 0...20 mA, 4...20 mA	RMPT70BD	0.120 0.264

#### Optimum converters for Pt100 probes (1)

Supply voltage  $\approx 24\text{ V} \pm 20\%$ , non isolated

Type	Temperature range		Output signal	Reference	Weight kg lb
	°C	°F			
Pt100 2-wire, 3-wire and 4-wire	-40...40	-40...104	0...10 V or 4...20 mA	RMPT13BD	0.120 0.264
	-100...100	-148...212	0...10 V or 4...20 mA	RMPT23BD	0.120 0.264
	0...100	32...212	0...10 V or 4...20 mA	RMPT33BD	0.120 0.264
	0...250	32...482	0...10 V or 4...20 mA	RMPT53BD	0.120 0.264
	0...500	32...932	0...10 V or 4...20 mA	RMPT73BD	0.120 0.264

(1) Converters dedicated to Zelio Logic smart relays.

# Analogue interfaces - Zelio Analog

## Converters for thermocouples and Pt100 probes

### Voltage/current converter



RMCN22BD



RMCL55BD



RMCA61BD

#### Universal voltage/current converters

##### Supply voltage $\approx 24\text{ V} \pm 20\%$ , non isolated

Input signal	Output signal	Reference	Weight kg lb
0...10 V or 4...20 mA	0...10 V or 4...20 mA	<b>RMCN22BD</b>	0.120 0.264

##### Supply voltage $\approx 24\text{ V} \pm 20\%$ , isolated

Input signal	Output signal	Reference	Weight kg lb
0...10 V, $\pm 10\text{ V}$ , 0...20 mA, 4...20 mA	Switchable: 0...10 V, $\pm 10\text{ V}$ , 0...20 mA, 4...20 mA	<b>RMCL55BD</b>	0.120 0.264
0...50 V, 0...300 V, 0...500 V $\approx$ or $\sim 50/60\text{ Hz}$	Switchable: 0...10 V, 0...20 mA, 4...20 mA	<b>RMCV60BD</b>	0.150 0.330
0...1.5 A, 0...5 A, 0...15 A $\approx$ or $\sim 50/60\text{ Hz}$	0...10 V or 0...20 mA or 4...20 mA	<b>RMCA61BD</b>	0.150 0.330

#### Connection accessories

Description	Type	Sold in lots of	Unit reference	Weight kg lb
Terminal blocks for connection of protective earth conductor	Screw	<b>100</b>	<b>AB1TP435U</b>	0.025 0.055
	Spring	<b>100</b>	<b>AB1RRNTP435U2</b>	0.010 0.055

170XTS04100	29	SR2CBL07	35	VW3A8306TF03	29
490NTW00002	29	SR2CBL08	20	VW3A8306TF10	29
490NTW00005	29	SR2CBL09	20		
490NTW00012	29	SR2COM01	35		
490NTW00040	29	SR2D101BD	17		
490NTW00080	29	SR2D101FU	17		
14210	21	SR2D201BD	17		
14211	21	SR2D201FU	17		
<b>A</b>		SR2E121B	17		
AB1RRNTP435U2	41	SR2E121BD	17		
AB1TP435U	41	SR2E121FU	17		
<b>H</b>		SR2E201B	17		
HMISTO501	20	SR2E201BD	17		
HMISTO705	20	SR2E201FU	17		
<b>R</b>		SR2MEM01	20		
RMCA61BD	36	SR2MEM02	20		
	41	SR2MOD02	35		
RMCL55BD	36	SR2PACK2BD	16		
	41	SR2PACK2FU	16		
RMCN22BD	36	SR2PACKBD	16		
	41	SR2PACKFU	16		
RMCV60BD	36	SR2SFT01	20		
	41	SR2SFT02	35		
RMPT10BD	36	SR2USB01	20		
	40	SR3B101B	18		
RMPT13BD	40	SR3B101BD	18		
RMPT20BD	36	SR3B101FU	18		
	40	SR3B102BD	18		
RMPT23BD	40	SR3B261B	18		
RMPT30BD	36	SR3B261BD	18		
	40	SR3B261FU	18		
RMPT33BD	40	SR3B261JD	18		
RMPT50BD	36	SR3B262BD	18		
	40	SR3MBU01BD	29		
RMPT53BD	40	SR3NET01BD	29		
RMPT70BD	36	SR3PACK2BD	18		
	40	SR3PACK2FU	18		
RMPT73BD	40	SR3PACKBD	18		
RMTJ40BD	36	SR3PACKFU	18		
	40	SR3XT43BD	31		
RMTJ60BD	36	SR3XT61B	19		
	40	SR3XT61BD	19		
RMTJ80BD	36	SR3XT61FU	19		
	40	SR3XT61JD	19		
RMTK80BD	36	SR3XT101B	19		
	40	SR3XT101BD	19		
RMTK90BD	36	SR3XT101FU	19		
	40	SR3XT101JD	19		
<b>S</b>		SR3XT141B	19		
SR1CBL03	35	SR3XT141BD	19		
SR2A101BD	16	SR3XT141FU	19		
SR2A101FU	16	SR3XT141JD	19		
SR2A201BD	16	<b>T</b>			
SR2A201E	16	TSXCSA100	29		
SR2A201FU	16	TSXCSA200	29		
SR2B121B	16	TSXCSA500	29		
SR2B121BD	16	TWDXCAISO	29		
SR2B121FU	16	TWDXCAT3RJ	29		
SR2B121JD	16	<b>V</b>			
SR2B122BD	16	VW3A8306R03	29		
SR2B201B	16	VW3A8306R10	29		
SR2B201BD	16	VW3A8306R30	29		
SR2B201FU	16	VW3A8306RC	29		
SR2B201JD	16				
SR2B202BD	16				
SR2BTC01	20				
SR2CBL01	20				

**Schneider Electric Industries SAS**

**msx**

Head Office  
35, rue Joseph Monier  
F-92500 Rueil-Malmaison  
France

The information provided in this documentation contains general descriptions and/or technical characteristics of the performance of the products contained herein. This documentation is not intended as a substitute for and is not to be used for determining suitability or reliability of these products for specific user applications. It is the duty of any such user or integrator to perform the appropriate and complete risk analysis, evaluation and testing of the products with respect to the relevant specific application or use thereof. Neither Schneider Electric nor any of its affiliates or subsidiaries shall be responsible or liable for misuse of the information contained herein.

Design: Schneider Electric  
Photos: Schneider Electric